







Datasheet

DC-Operated LED Indicators with 150mm PUR cable QD

Models

Models	Construction	Connector ³	LED Function ⁴	Inputs	
	M18GXRPQMA	150 mm (6 in) PUR Pigtail with 4-pin Euro-style QD fitting	3-color ¹	PNP (Sourcing)	
	M18GXRNQMA			NPN (Sinking)	
	M18RGX7PQPMA		IP67	2-color ²	PNP (Sourcing)
	T18GXRPQMA		Thermoplastic polyester housing, thermoplastic diffuser. Fully encapsulated.	3-color ¹	PNP (Sourcing)
	T18GXRNQMA				NPN (Sinking)
	T18RGX7PQPMA		IP67	2-color ²	PNP (Sourcing)
	T30GXRPQMA		Thermoplastic polyester housing, thermoplastic diffuser. Fully encapsulated.	3-color ¹	PNP (Sourcing)
	T30GXRNQMA				NPN (Sinking)
	T30RGX7PQPMA		IP67	2-color ²	PNP (Sourcing)
	K30LGXRPQMA	22 mm threaded polycarbonate base, translucent polycarbonate dome. Fully encapsulated.	3-color ¹	PNP (Sourcing)	
	K30LGXRNQMA			NPN (Sinking)	
	K30LRGX7PQPMA	IP67, IP69K	2-color ²	PNP (Sourcing)	
	K50LRGX7PQPMA	30 mm threaded polycarbonate base, translucent polycarbonate dome. Fully encapsulated.	2-color ²	PNP (Sourcing)	
	K50FLRGX7PQPMA	Polycarbonate base, translucent polycarbonate dome. Fully encapsulated.	2-color ²	PNP (Sourcing)	
	K80LRGX7PQPMA	ABS and polycarbonate base, translucent polycarbonate dome. Electronics fully encapsulated.	2-color ²	PNP (Sourcing)	
		IP67			

¹ Use with PNP or NPN I/O blocks to produce Green, Red, or Yellow indicator functions (see [Wiring Diagrams](#) on page 2).

² Use with discrete-output sensors to provide remote indication. Red is ON when the sensor is powered, Green is ON when the output is energized.

³ Mating cable required. For use with mating Euro-style QD cables or with Euro splitter, model **CSB-M1240M1240**, or equivalent.

⁴ Contact Banner Engineering for other colors and color combinations, including: blue, white, orange.



Wiring Diagrams

PNP (..GXRP..) 3-Color Models

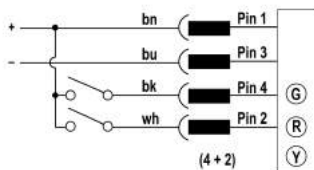

NPN (..GXRN..) 3-Color Models

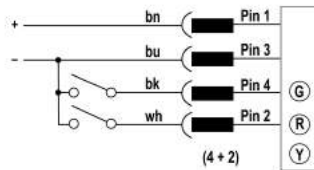

2-Color (..RGX7P..) Models

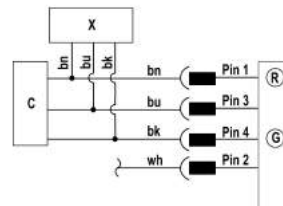

NOTE: When "G" is ON, "R" is OFF

Pinout

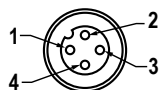

Key

1 = Brown
2 = White
3 = Blue
4 = Black

X = Banner Sensor
C = Control Box
G = Green
R = Red
Y = Yellow

Specifications

Supply Voltage and Current

K30L, T18, and M18 Models:

2-color models: 10 V dc to 30 V dc at 30 mA max.

3-color models: 10 V dc to 30 V dc at 25 mA max. per color

T30 models:

2-color models: 10 V dc to 30 V dc at 50 mA max.

3-color models: 10 V dc to 30 V dc at 40 mA max. per color

K50L, K50FL, and K80L Models:

2-color models: 18 V dc to 30 V dc at 50 mA max.

Indicators

Entire translucent diffuser or dome provides indication. See notes 1 and 2 under *Models* on page 1. For other colors/combinations, contact Banner Engineering for availability.

Construction

See *Models* on page 1

Connections

150 mm (6 in) PUR cable with 4-pin M12/Euro-style quick disconnect

Environmental Rating

Rated IEC IP67. K80L has encapsulated electronics only; other models fully encapsulated.

K30L, K50L, and K50FL quick-disconnect models meet IP69K per DIN 40050-9.

Cabled models also meet IP69K if the cable and cable entrance are protected from high-pressure spray.

Operating Conditions

-40 °C to +50 °C (-40 °F to +122 °F)

Dimensions

M18 Models

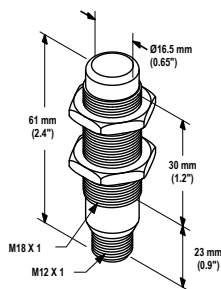

K30L Models

T18 Models

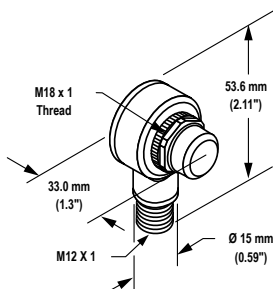

T30 Models

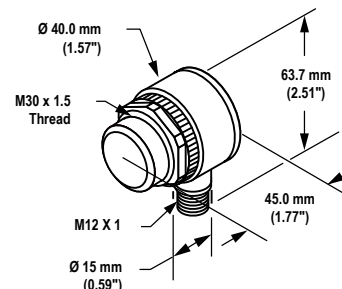

K50L Models

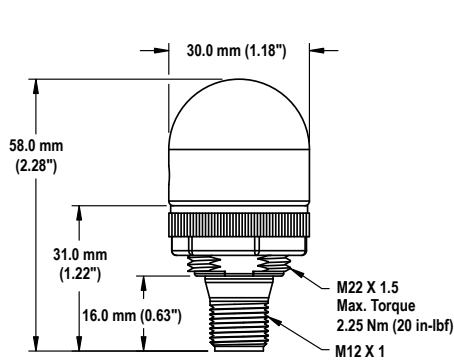

K50FL Models

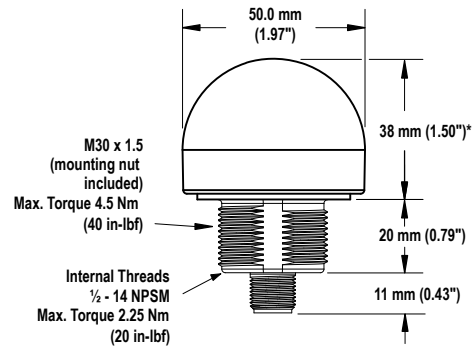

K80L Models

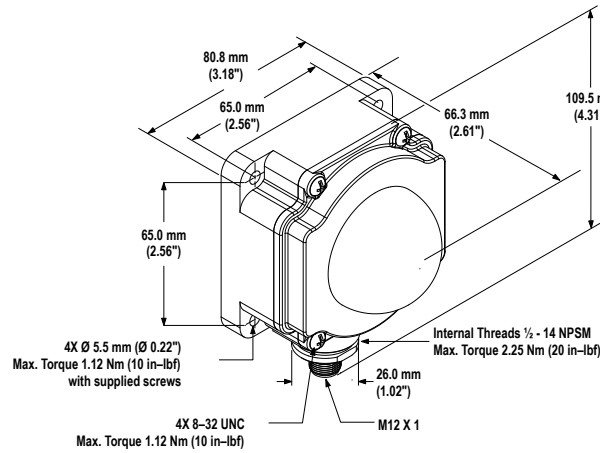
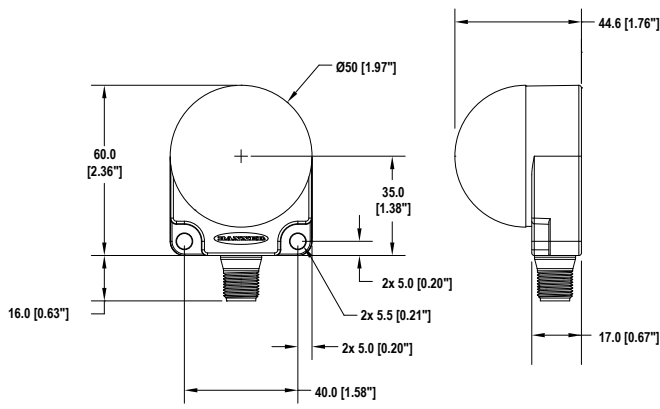

Accessories

Cordsets

4-Pin Threaded M12/Euro-Style Cordsets—Single Ended				
Model	Length	Style	Dimensions	Pinout (Female)
MQDC-406	1.83 m (6 ft)	Straight		<p>1 = Brown 2 = White 3 = Blue 4 = Black</p>
MQDC-415	4.57 m (15 ft)			
MQDC-430	9.14 m (30 ft)			
MQDC-450	15.2 m (50 ft)	Right-Angle		
MQDC-406RA	1.83 m (6 ft)			
MQDC-415RA	4.57 m (15 ft)			
MQDC-430RA	9.14 m (30 ft)			
MQDC-450RA	15.2 m (50 ft)			

4-Pin Threaded M12/Euro-Style Cordsets—Double Ended				
Model	Length	Style	Dimensions	Pinout
MQDEC-401SS	0.31 m (1 ft)	Male Straight/ Female Straight		<p>Female</p> <p>Male</p> <p>1 = Brown 2 = White 3 = Blue 4 = Black</p>
MQDEC-403SS	0.91 m (3 ft)			
MQDEC-406SS	1.83 m (6 ft)			
MQDEC-412SS	3.66 m (12 ft)			
MQDEC-420SS	6.10 m (20 ft)			
MQDEC-430SS	9.14 m (30 ft)			
MQDEC-450SS	15.2 m (50 ft)	Male Right-Angle/ Female Straight		<p>1 = Brown 2 = White 3 = Blue 4 = Black</p>
MQDEC-403RS	0.91 m (1 ft)			
MQDEC-406RS	1.83 m (3 ft)			
MQDEC-412RS	3.66 m (12 ft)			
MQDEC-420RS	6.10 m (20 ft)			
MQDEC-430RS	9.14 m (30 ft)			
MQDEC-450RS	15.2 m (50 ft)			

4-Pin Threaded M12/Euro-Style Splitter Cordsets—Flat Junction			
Model	Branches (Female)	Trunk (Male)	Pinout
CSB-M1240M1240	No branch	No trunk	<p>Female</p> <p>Male</p> <p>1 = Brown 2 = White 3 = Blue 4 = Black</p>
CSB-M1240M1241	2 x 0.30 m (1 ft)	No trunk	
CSB-M1241M1241		0.30 m (1 ft)	
CSB-M1248M1241		2.50 m (8 ft)	
CSB-M12415M1241		4.57 m (15 ft)	
CSB-M12425M1241		7.60 m (25 ft)	
CSB-UNT425M1241		7.60 m (25 ft) Unterminated	

Mounting Brackets

For more information about these and other available brackets, visit www.bannerengineering.com.

K50FL models include a 48 mm (1.9 in) circular hook-and-loop mounting kit for easy mounting with no additional hardware required.

For use with M18 and T18 models or base-mount T30 models

SMB18A

- Right-angle mounting bracket with a curved slot for versatile orientation
- 12-ga. stainless steel
- 18 mm sensor mounting hole
- Clearance for M4 (#8) hardware

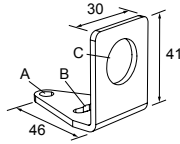

Hole center spacing: A to B = 24.2

Hole size: A = \varnothing 4.6, B = 17.0 x 4.6, C = \varnothing 18.5

SMB312PD

- Right-angle mounting bracket with a curved slot for versatile orientation
- 12-ga. stainless steel
- 18 mm sensor mounting hole
- Clearance for M4 (#8) hardware

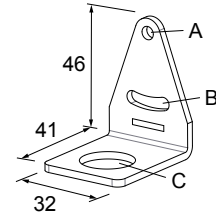

Hole center spacing: A to B = 24.2

Hole size: A = \varnothing 4.6, B = 17 x 4.6, C = \varnothing 18.5



Note: Not for use with plastic fiber optic sensors

SMB1815SF

- Swivel with set screws for mounting sensors by the cable hub
- Black reinforced thermoplastic polyester
- Stainless steel swivel locking hardware and hex wrench included

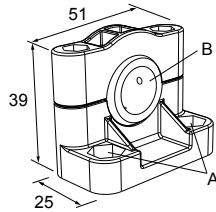

Hole center spacing: A = 36.0

Hole size: A = \varnothing 5.0, B = \varnothing 15.0

SMBAMS18RA

- Right-angle SMBAMS series bracket with 18 mm hole
- Articulation slots for 90+° rotation
- 12-ga. (2.6 mm) cold-rolled steel

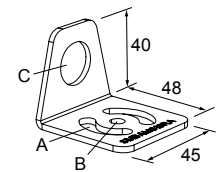

Hole center spacing: A = 26.0, A to B = 13.0

Hole size: A = 26.8 x 7.0, B = \varnothing 6.5, C = \varnothing 19.0

SMB18Q

- Right-angle flanged bracket
- 18 mm sensor mounting hole
- 12-ga. stainless steel

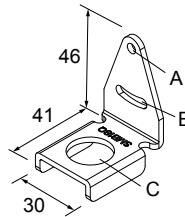

Hole center spacing: A to B = 24.2

Hole size: A = \varnothing 4.6, B = 17.0 x 4.6, C = \varnothing 19.0

SMBAMS18P

- Flat SMBAMS series bracket with 18 mm hole
- Articulation slots for 90+° rotation
- 12-ga. (2.6 mm) cold-rolled steel

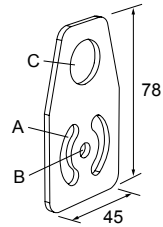

Hole center spacing: A = 26.0, A to B = 13.0

Hole size: A = 26.8 x 7.0, B = \varnothing 6.5, C = \varnothing 19.0

SMB18SF

- 18 mm swivel bracket with M18 x 1 internal thread
- Black thermoplastic polyester
- Stainless steel swivel locking hardware included

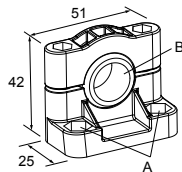

Hole center spacing: A = 36.0

Hole size: A = \varnothing 5.3, B = \varnothing 18.0

For use with base-mount K30L models

SMB22A

- Right-angle bracket with curved slot for versatile orientation
- 12-ga. stainless steel
- Mounting hole for 22 mm sensor

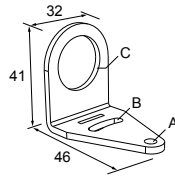

Hole center spacing: A to B = 26.0

Hole size: A = \varnothing 4.6, B = 4.6 x 16.9, C = 22.2

For use with T30 models or base-mount K50L models

SMB30A

- Right-angle bracket with curved slot for versatile orientation
- Clearance for M6 (1/4 in) hardware
- Mounting hole for 30 mm sensor
- 12-ga. stainless steel

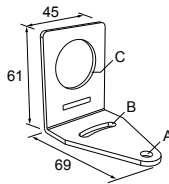

Hole center spacing: A to B=40

Hole size: A= \varnothing 6.3, B= 27.1 x 6.3, C= \varnothing 30.5

SMB30SC

- Swivel bracket with 30 mm mounting hole for sensor
- Black reinforced thermoplastic polyester
- Stainless steel mounting and swivel locking hardware included

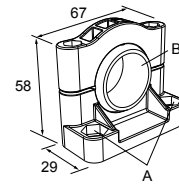

Hole center spacing: A= \varnothing 50.8

Hole size: A= \varnothing 7.0, B= \varnothing 30.0

SMBAMS30RA

- Right-angle SMBAMS series bracket
- 30 mm hole for mounting sensors
- Articulation slots for 90°+ rotation
- 12-ga. (2.6 mm) cold-rolled steel

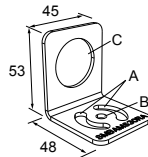

Hole center spacing: A=26.0, A to B=13.0

Hole size: A=26.8 x 7.0, B= \varnothing 6.5, C= \varnothing 31.0

SMB30MM

- 12-ga. stainless steel bracket with curved mounting slots for versatile orientation
- Clearance for M6 (1/4 in) hardware
- Mounting hole for 30 mm sensor

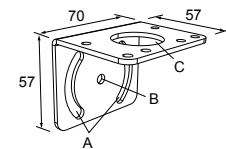

Hole center spacing: A = 51, A to B = 25.4

Hole size: A = 42.6 x 7, B = \varnothing 6.4, C = \varnothing 30.1

SMBAMS30P

- Flat SMBAMS series bracket
- 30 mm hole for mounting sensors
- Articulation slots for 90°+ rotation
- 12-ga. 300 series stainless steel

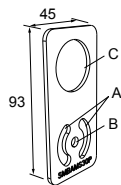

Hole center spacing: A=26.0, A to B=13.0

Hole size: A=26.8 x 7.0, B= \varnothing 6.5, C= \varnothing 31.0

SMB3018SC

- 18 mm swivel side or barrel-mount bracket
- Black reinforced thermoplastic polyester
- Stainless steel swivel locking hardware included

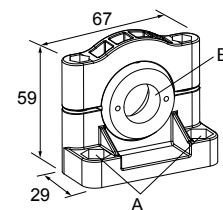

Hole center spacing: A = 50.8

Hole size: A = \varnothing 7.0, B = \varnothing 18.0

DIN-mount bracket for K80L models

SMBDX80DIN

- Black reinforced thermoplastic
- Bracket for mounting on a 35 mm DIN rail

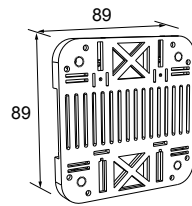

Banner Engineering Corp. Limited Warranty

Banner Engineering Corp. warrants its products to be free from defects in material and workmanship for one year following the date of shipment. Banner Engineering Corp. will repair or replace, free of charge, any product of its manufacture which, at the time it is returned to the factory, is found to have been defective during the warranty period. This warranty does not cover damage or liability for misuse, abuse, or the improper application or installation of the Banner product.

THIS LIMITED WARRANTY IS EXCLUSIVE AND IN LIEU OF ALL OTHER WARRANTIES WHETHER EXPRESS OR IMPLIED (INCLUDING, WITHOUT LIMITATION, ANY WARRANTY OF MERCHANTABILITY OR FITNESS FOR A PARTICULAR PURPOSE), AND WHETHER ARISING UNDER COURSE OF PERFORMANCE, COURSE OF DEALING OR TRADE USAGE.

This Warranty is exclusive and limited to repair or, at the discretion of Banner Engineering Corp., replacement. **IN NO EVENT SHALL BANNER ENGINEERING CORP. BE LIABLE TO BUYER OR ANY OTHER PERSON OR ENTITY FOR ANY EXTRA COSTS, EXPENSES, LOSSES, LOSS OF PROFITS, OR ANY INCIDENTAL, CONSEQUENTIAL OR SPECIAL DAMAGES RESULTING FROM ANY PRODUCT DEFECT OR FROM THE USE OR INABILITY TO USE THE PRODUCT, WHETHER ARISING IN CONTRACT OR WARRANTY, STATUTE, TORT, STRICT LIABILITY, NEGLIGENCE, OR OTHERWISE.**

Banner Engineering Corp. reserves the right to change, modify or improve the design of the product without assuming any obligations or liabilities relating to any product previously manufactured by Banner Engineering Corp. Any misuse, abuse, or improper application or installation of this product or use of the product for personal protection applications when the product is identified as not intended for such purposes will void the product warranty. Any modifications to this product without prior express approval by Banner Engineering Corp will void the product warranties. All specifications published in this document are subject to change; Banner reserves the right to modify product specifications or update documentation at any time. Specifications and product information in English supersede that which is provided in any other language. For the most recent version of any documentation, refer to: www.bannerengineering.com.

For patent information, see www.bannerengineering.com/patents.