

## Datasheet

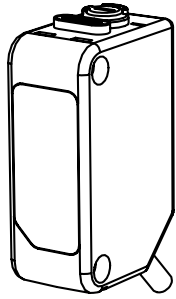

- Photoelectric sensors in a compact, rugged, sealed, over-molded plastic housing
- Standard 3 mm threaded mounting holes on 25.4 mm (1 in) spacing
- Advanced electronic design for excellent noise immunity and cross-talk avoidance
- Threaded metal M8 connector on Pico-style quick-disconnect models
- 10 V dc to 30 V dc operation with complementary solid-state outputs (1 normally open, 1 normally closed); PNP or NPN, depending on model
- Complete offering of mounting brackets and apertures available
- Crosstalk prevention filters available for visible red opposed mode pairs
- Exceptional optical performance with easy to align visible red emitters
- Background suppression models provide reliable detection up to 150 mm while ignoring objects in the background
- Background suppression models provide stable detection in the presence of fluorescent lights



### WARNING:

- **Do not use this device for personnel protection**
- Using this device for personnel protection could result in serious injury or death.
- This device does not include the self-checking redundant circuitry necessary to allow its use in personnel safety applications. A device failure or malfunction can cause either an energized (on) or de-energized (off) output condition.

## Models

Model <sup>1</sup>	Sensing Mode	Range	Output <sup>2</sup>	Model <sup>1</sup>	Sensing Mode	Range	Output <sup>2</sup>
Q20E	Opposed, 624 nm Visible Red Effective Beam: 10 mm (0.4 in)	12 m (39.4 ft)	N/A	Q20PDXL	Long Range Diffuse, 850 nm Infrared	1500 mm (59 in)	PNP
Q20PR			PNP	Q20NDXL			NPN
Q20NR			NPN	Q20PD	PNP		
Q20EL	Opposed, 850 nm Infrared Effective Beam: 10 mm (0.4 in)	20 m (65.6 ft)	N/A	Q20ND	Short Range Diffuse, 624 nm Visible Red	250 mm (10 in)	NPN
Q20PRL			PNP	Q20PDVS			PNP
Q20NRL			NPN	Q20NDVS	NPN		
Q20PLP	Polarized Retroreflective, 645 nm Visible Red	4 m (13 ft) (specified using reflector BRT-84)	PNP	Q20PFF50	Fixed Field, 655 nm Visible Red	50 mm (2 in) cutoff	PNP
Q20NLP			NPN	Q20NFF50			NPN
Q20PLV	Retroreflective, 645 nm Visible Red	6 m (20 ft) (specified using reflector BRT-84)	PNP	Q20PFF100	100 mm (4 in) cutoff		PNP
Q20NLV			NPN	Q20NFF100			NPN
Q20PDL	Long-Range Diffuse, 624 nm Visible Red	800 mm (32 in)	PNP	Q20PFF150	150 mm (6 in) cutoff		PNP
Q20NDL			NPN	Q20NFF150			NPN

Diffuse-mode and fixed-field performances are based on the use of a 90% reflectance white test card.

<sup>1</sup> Integral 2 m (6.5 ft) unterminated cable models are listed.

- To order the 9 m (30 ft) PVC cable model, add the suffix "W/30" to the cabled model number. For example, Q20E W/30.
- To order the 4-pin M8/Pico-style integral quick disconnect model, add the suffix "Q7" to the model number. For example, Q20EQ7.
- To order the 150 mm (6 in) PVC cable model with a 4-pin M8/Pico-style quick disconnect, add the suffix "Q" to the model number. For example, Q20EQ.
- To order the 150 mm (6 in) PVC cable model with a 4-pin M12/Euro-style quick disconnect, add the suffix "Q5" to the model number. For example, Q20EQ5.
- To order the 150 mm (6 in) PUR cable model with a 4-pin M12/Euro-style quick disconnect, add the suffix "QPMA" to the model number. For example, Q20EQPMA.
- Models with a quick disconnect require a mating cordset.

<sup>2</sup> Available with Health or Alarm Mode output; contact Banner Engineering for details.



## Overview

Banner's Q20 family of sensors offers a full complement of sensing modes, with the excellent performance expected of much larger sensors. Their compact plastic housings feature overmolded construction for superior robustness and sealing. Their popular rectangular design is easy to mount into tight spaces; integral threaded mounting holes eliminate the need for separate mounting nuts.

The single-turn Gain potentiometer on most models and bright LEDs (positioned on top of the housing for 360° visibility) provide easy alignment and configuration for reliable sensing.

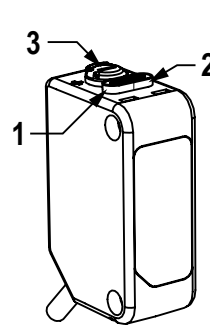

(varies with model)

1. Output LED
2. Power LED
3. Single-Turn Gain Potentiometer (Retro and Diffuse models only)

## Wiring Diagrams

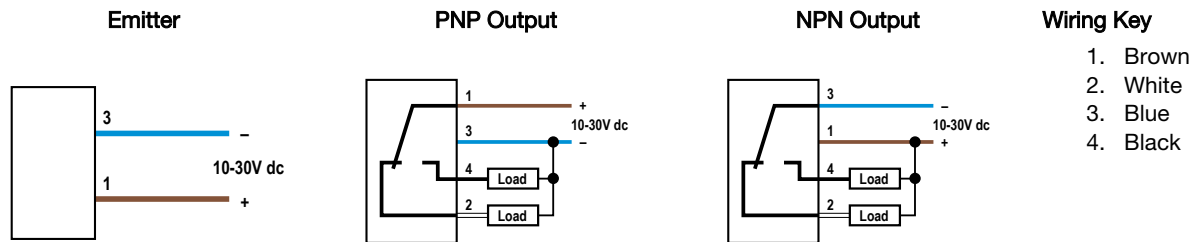

Cabled wiring diagrams are shown. Quick disconnect wiring diagrams are functionally identical.

## Specifications

### Supply Voltage

**Fixed-Field:** 10 to 30V dc (10% maximum ripple within specified limits) at less than 25 mA, exclusive of load  
**All others:** 10 to 30V dc (10% maximum ripple within specified limits) at less than 18 mA, exclusive of load

### Supply Protection Circuitry

Protected against reverse polarity and transient voltages

### Output Configuration for Receiver

100 mA with short circuit protection  
 OFF-state leakage current:  
 NPN: < 200  $\mu$ A sinking (see Application Note 2);  
 PNP: < 10  $\mu$ A sourcing  
 ON-state saturation voltage  
 NPN: < 1.6 V at 100 mA  
 PNP: < 3.0 V at 100 mA

### Output Configuration for all Other Models

Maximum Current  $\leq$  100 mA  
 PNP Output Voltage:  
 High  $\geq$   $V_{supply} - V_{saturation}$   
 Low  $\leq$  1 V ( $\leq$  1M  $\Omega$ )  
 NPN Output Voltage:  
 High  $\geq$   $V_{supply} - 1$  V ( $\leq$  1M  $\Omega$ )  
 Low  $\leq$   $V_{saturation}$   
 $V_{saturation} \leq$  3 V

### Output Response Time

Opposed mode: 1 millisecond ON/600 microseconds OFF  
 All other models: 850 microseconds ON/OFF  
 100 millisecond delay on power-up; outputs do not conduct during this time

### Repeatability

Opposed mode: 140 microseconds  
 All other models: 90 microseconds

### Construction

ABS housing; PMMA lenses; PBT Gain Adjuster (Retro and Diffuse models only)

### Connections

2 m (6.5 ft) or 9 m (30 ft) 4-wire PVC cable, 150 mm (6 in) pigtail with 4-pin threaded Pico-style (Q) or Euro-style (Q5) connector, or 4-pin integral threaded Pico-style connector (Q7), depending on model

### Indicators

Two LED Indicators: Power (green) and Output (amber)  
 Fixed-Field models:  
 Green on: Power ON  
 Amber on: Black (LO) wire conducting  
 All other models:  
 Green on: Power ON  
 Amber on: Black (LO) wire conducting  
 Amber flashing: Marginal excess gain (1 to 1.5x)  
 Black (LO) wire conducting

### Adjustments

**Diffuse, Retroreflective, and Polarized Retroreflective models (only):**  
 Single-turn Sensitivity (Gain) adjustment potentiometer

**Applications Notes**

1. Opposed mode sensor spacing can be reduced by alternating emitters and receivers or by applying cross talk filters (visible red models only)
2. For receiver only: NPN off-state leakage current is <200 µA for load resistances > 3kΩ or optically isolated loads. For load currents of 100 mA, leakage is <1% of load current.

**Operating Conditions**

-20 °C to +60 °C (-4 °F to +140 °F)  
95% at +50 °C maximum relative humidity (non-condensing)

**Environmental Rating**

IEC IP67; NEMA 6

All models meet MIL-STD-202F, Method 201A (Vibration: 10 Hz to 60 Hz maximum, 0.06 inch (1.52 mm) double amplitude, 10G maximum acceleration) requirements. Also meets IEC 60947-5-2 (Shock: 30G 11 ms duration, half sine wave) requirements.

**Certifications**



(Class 2 power supply required)

**Required Overcurrent Protection**



**WARNING:** Electrical connections must be made by qualified personnel in accordance with local and national electrical codes and regulations.

Overcurrent protection is required to be provided by end product application per the supplied table.  
Overcurrent protection may be provided with external fusing or via Current Limiting, Class 2 Power Supply.  
Supply wiring leads < 24 AWG shall not be spliced.  
For additional product support, go to [www.bannerengineering.com](http://www.bannerengineering.com).

Supply Wiring (AWG)	Required Overcurrent Protection (Amps)
20	5.0
22	3.0
24	2.0
26	1.0
28	0.8
30	0.5

**Performance Curves**

**Opposed Mode Models**

**Excess Gain**

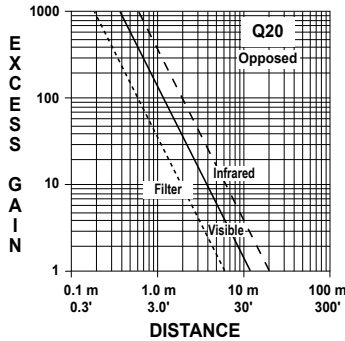

**Beam Pattern**

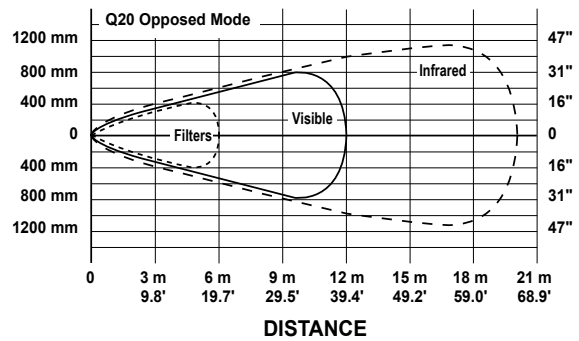

**Retroreflective Mode Models (based on retroreflector BRT-84)**

**Excess Gain**

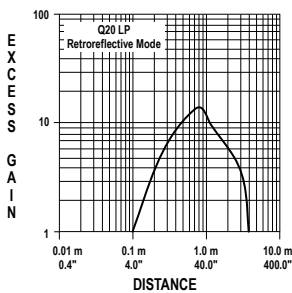

**Beam Pattern**

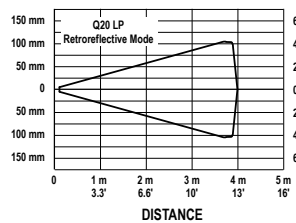

**Excess Gain**

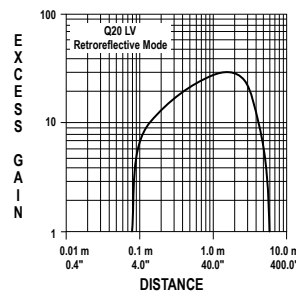

**Beam Pattern**

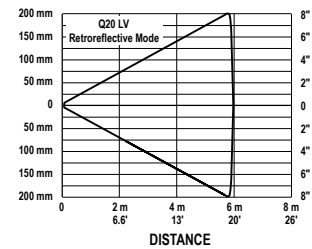

Diffuse Mode Models (based on 90% reflectance white test card)

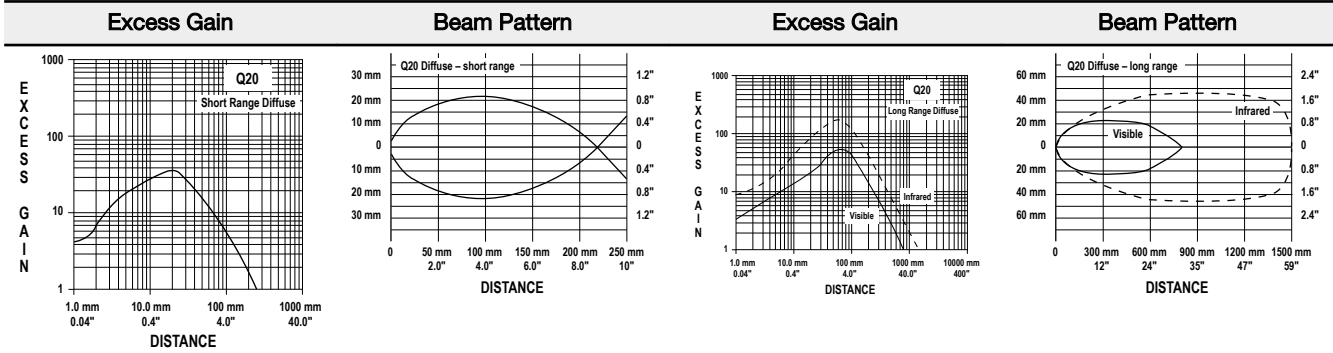

Q20DVS Models

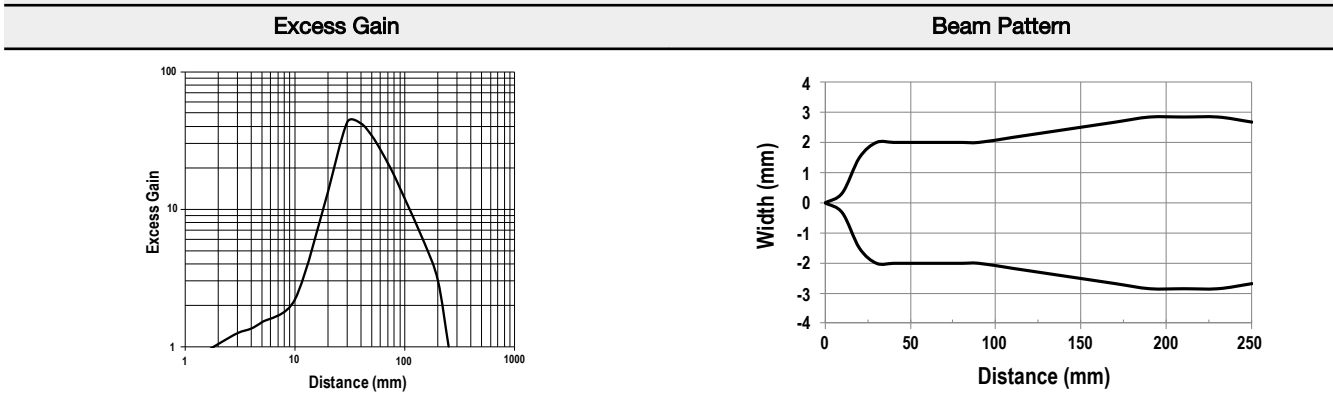

Fixed-Field Excess Gain (based on 90% reflectance white test card)

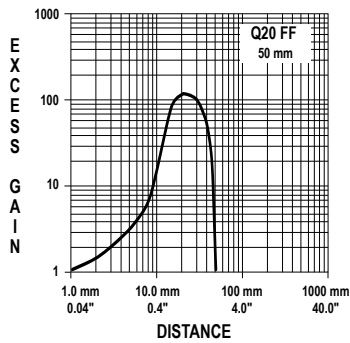

Ø 6 mm spot size at 25 mm  
 Ø 6 mm spot size at 50 mm cutoff  
**Using 18% gray test card:** cutoff distance will be 95% of value shown  
**Using 6% black test card:** cutoff distance will be 90% of value shown

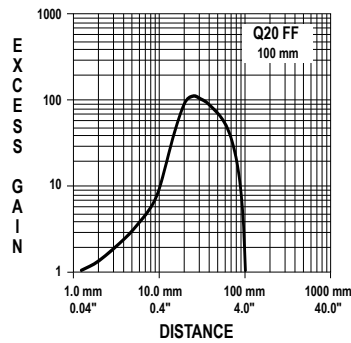

Ø 6 mm spot size at 50 mm  
 Ø 6 mm spot size at 100 mm cutoff  
**Using 18% gray test card:** cutoff distance will be 90% of value shown  
**Using 6% black test card:** cutoff distance will be 85% of value shown

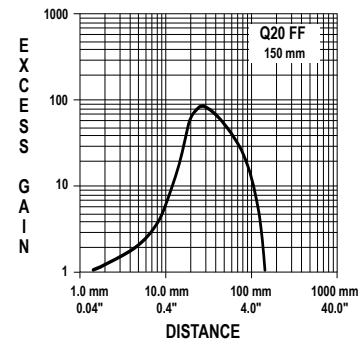

Ø 6 mm spot size at 75 mm  
 Ø 9 mm spot size at 150 mm cutoff  
**Using 18% gray test card:** cutoff distance will be 80% of value shown  
**Using 6% black test card:** cutoff distance will be 70% of value shown

See [Accessories](#) on page 5, the Accessories section of the current Banner catalog, or [www.bannerengineering.com](http://www.bannerengineering.com) for complete information.



**Note:** Polarized sensors require corner cube type retroreflective targets only.

## Dimensions

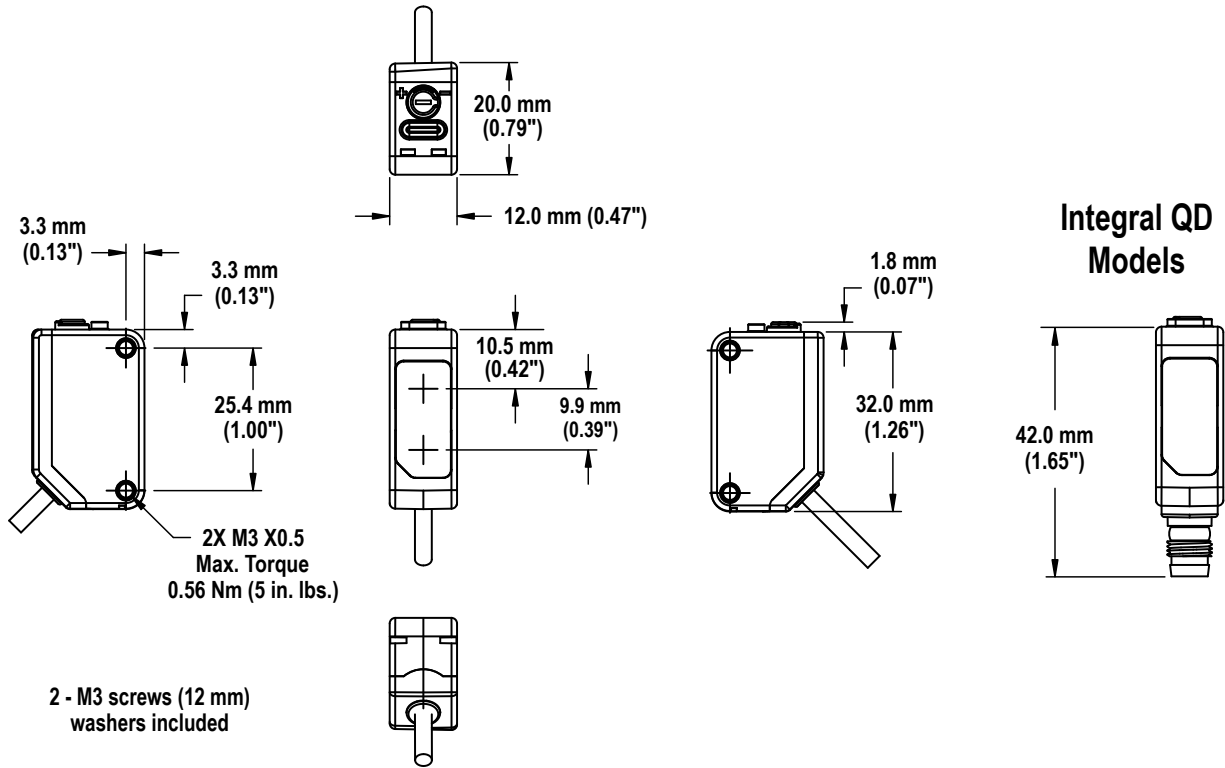

### Cabled and Pigtail QD Models



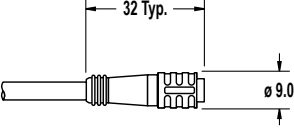

## Accessories

### Quick-Disconnect (QD) Cordsets

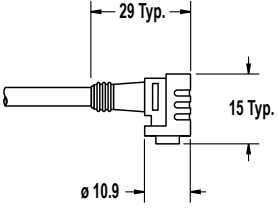
4-Pin Threaded M12/Euro-Style Cordsets—Single Ended				
Model	Length	Style	Dimensions	Pinout (Female)
MQDC-406	1.83 m (6 ft)	Straight		<p>1 = Brown 2 = White 3 = Blue 4 = Black</p>
MQDC-415	4.57 m (15 ft)			
MQDC-430	9.14 m (30 ft)			
MQDC-450	15.2 m (50 ft)	Right-Angle		
MQDC-406RA	1.83 m (6 ft)			
MQDC-415RA	4.57 m (15 ft)			
MQDC-430RA	9.14 m (30 ft)			
MQDC-450RA	15.2 m (50 ft)			

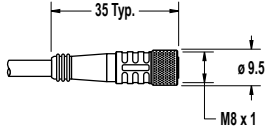
4-Pin Snap-on M8/Pico-Style Cordsets—Single Ended				
Model	Length	Style	Dimensions	Pinout (Female)
PKG4-2	2 m (6.56 ft)	Straight		 <p>1 = Brown 2 = White 3 = Blue 4 = Black</p>
PKW4Z-2	2 m (6.56 ft)	Right-Angle		

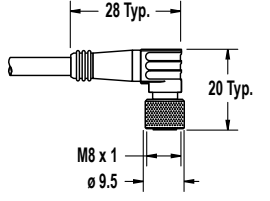
4-Pin Threaded M8/Pico-Style Cordsets—Single Ended				
Model	Length	Style	Dimensions	Pinout (Female)
PKG4M-2	2 m (6.56 ft)	Straight		 <p>1 = Brown 2 = White 3 = Blue 4 = Black</p>
PKG4M-5	5 m (16.4 ft)			
PKG4M-9	9 m (29.5 ft)			
PKW4M-2	2 m (6.56 ft)	Right Angle		
PKW4M-5	5 m (16.4 ft)			
PKW4M-9	9 m (29.5 ft)			

## Mounting Brackets

### SMBQ20L

- Sensor vertical base mount
- ±5° tip, ±7° swivel
- Stainless steel

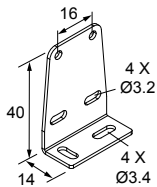

### SMBQ20LV

- Sensor vertical back mount
- ±10° tip
- Stainless steel

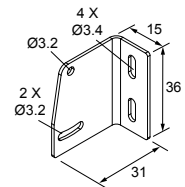

### SMBQ20H

- Sensor horizontal flange mount
- ±10° swivel
- Stainless steel

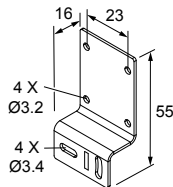

### SMBQ20U

- Sensor vertical base mount with protection
- ±22.5° swivel
- Stainless steel

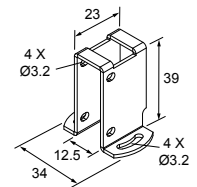

## Cross Talk Prevention Filters

Model <sup>3</sup>	Description	Reduced Sensor Range E/R (two apertures used)
PFQ20-H	 Stainless steel (natural color)	7.5 mm (0.3 in) dia.
PFQ20-V		
		6.0 m (21.3 in)

## Apertures

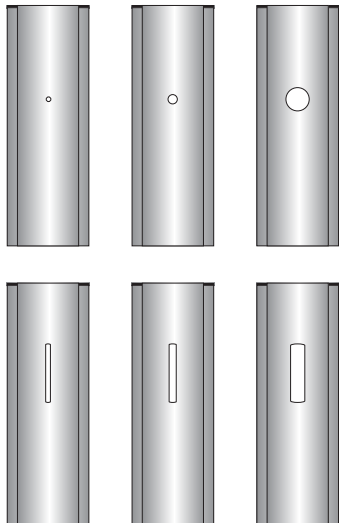
Model		Reduced Sensor Range E/R (two apertures used)	Reduced Sensor Range EL/RL (two apertures used)	Description	
<b>Circular</b>					
APQ20-0.5	0.5 mm (0.02") dia.	0.10 m (0.33 ft)	0.18 m (0.6 ft)		
APQ20-1	1 mm (0.04") dia.	0.35 m (1.14 ft)	0.66 m (2.1 ft)		
APQ20-2	2 mm (0.08") dia.	1.5 m (4.9 ft)	2.9 m (9.5 ft)		
<b>Vertical Slot</b>					
APQ20-0.5V	0.5 mm (0.02") dia.	1.4 m (4.6 ft)	2.3 m (7.5 ft)		
APQ20-1V	1 mm (0.04") dia.	2.8 m (9.2 ft)	4.8 m (15.7 ft)		
APQ20-2V	2 mm (0.08") dia.	5.8 m (19.0 ft)	8.6 m (28.2 ft)		
APK-Q20	Includes two of each type				

## Banner Engineering Corp. Limited Warranty

Banner Engineering Corp. warrants its products to be free from defects in material and workmanship for one year following the date of shipment. Banner Engineering Corp. will repair or replace, free of charge, any product of its manufacture which, at the time it is returned to the factory, is found to have been defective during the warranty period. This warranty does not cover damage or liability for misuse, abuse, or the improper application or installation of the Banner product.

**THIS LIMITED WARRANTY IS EXCLUSIVE AND IN LIEU OF ALL OTHER WARRANTIES WHETHER EXPRESS OR IMPLIED (INCLUDING, WITHOUT LIMITATION, ANY WARRANTY OF MERCHANTABILITY OR FITNESS FOR A PARTICULAR PURPOSE), AND WHETHER ARISING UNDER COURSE OF PERFORMANCE, COURSE OF DEALING OR TRADE USAGE.**

This Warranty is exclusive and limited to repair or, at the discretion of Banner Engineering Corp., replacement. **IN NO EVENT SHALL BANNER ENGINEERING CORP. BE LIABLE TO BUYER OR ANY OTHER PERSON OR ENTITY FOR ANY EXTRA COSTS, EXPENSES, LOSSES, LOSS OF PROFITS, OR ANY INCIDENTAL, CONSEQUENTIAL OR SPECIAL DAMAGES RESULTING FROM ANY PRODUCT DEFECT OR FROM THE USE OR INABILITY TO USE THE PRODUCT, WHETHER ARISING IN CONTRACT OR WARRANTY, STATUTE, TORT, STRICT LIABILITY, NEGLIGENCE, OR OTHERWISE.**

Banner Engineering Corp. reserves the right to change, modify or improve the design of the product without assuming any obligations or liabilities relating to any product previously manufactured by Banner Engineering Corp. Any misuse, abuse, or improper application or installation of this product or use of the product for personal protection applications when the product is identified as not intended for such purposes will void the product warranty. Any modifications to this product without prior express approval by Banner Engineering Corp will void the product warranties. All specifications published in this document are subject to change; Banner reserves the right to modify product specifications or update documentation at any time. Specifications and product information in English supersede that which is provided in any other language. For the most recent version of any documentation, refer to: [www.bannerengineering.com](http://www.bannerengineering.com).

For patent information, see [www.bannerengineering.com/patents](http://www.bannerengineering.com/patents).

<sup>3</sup> For visible red models only. The "H" and "V" in the model numbers refer to the polarization of the filter material. Since they are visually identical, the "H" models have been left the natural stainless steel and the "V" models have been colored black.

## FCC Part 15 and CAN ICES-3 (B)/NMB-3(B)

This device complies with part 15 of the FCC Rules and CAN ICES-3 (B)/NMB-3(B). Operation is subject to the following two conditions:

1. This device may not cause harmful interference, and
2. This device must accept any interference received, including interference that may cause undesired operation.

This equipment has been tested and found to comply with the limits for a Class B digital device, pursuant to part 15 of the FCC Rules and CAN ICES-3 (B)/NMB-3(B). These limits are designed to provide reasonable protection against harmful interference in a residential installation. This equipment generates, uses and can radiate radio frequency energy and, if not installed and used in accordance with the instructions, may cause harmful interference to radio communications. However, there is no guarantee that interference will not occur in a particular installation. If this equipment does cause harmful interference to radio or television reception, which can be determined by turning the equipment off and on, the user is encouraged to try to correct the interference by one or more of the following measures:

- Reorient or relocate the receiving antenna.
- Increase the separation between the equipment and receiver.
- Connect the equipment into an outlet on a circuit different from that to which the receiver is connected.
- Consult the manufacturer.



more sensors, more solutions