

# Q4X Stainless Steel Analog Laser Sensor

## Instruction Manual

Original Instructions  
185624 Rev. E  
21 November 2017  
© Banner Engineering Corp. All rights reserved



185624

# Contents

<b>1 Product Description</b>	3
1.1 Models	3
1.2 Overview	3
1.3 Features	4
1.3.1 Display and Indicators	4
1.3.2 Buttons	4
1.4 Laser Description and Safety Information	5
<b>2 Installation</b>	6
2.1 Install the Safety Label	6
2.2 Sensor Orientation	6
2.3 Mount the Sensor	6
2.4 Wiring Diagram	7
2.5 Cleaning and Maintenance	7
<b>3 Sensor Programming</b>	8
3.1 Setup Mode	8
3.1.1 TEACH Menu	10
3.1.2 Base Measurement Rate	10
3.1.3 Averaging	10
3.1.4 Slope	11
3.1.5 Zero Reference Location	12
3.1.6 Shift the Zero Reference Location after a TEACH	12
3.1.7 Loss of Signal	13
3.1.8 Input Wire Function	14
3.1.9 Trigger	14
3.1.10 Display View	15
3.1.11 Exit Setup Mode	15
3.1.12 Reset to Factory Defaults	15
3.2 Manual Adjustments	16
3.2.1 Manual Adjustments in Two-Point TEACH Mode	16
3.2.2 Manual Adjustments in One-Point TEACH Mode	17
3.3 Remote Input	17
3.3.1 Select the TEACH Mode Using the Remote Input	17
3.3.2 Reset to Factory Defaults Using the Remote Input	18
3.4 Locking and Unlocking the Sensor Buttons	18
3.5 TEACH Procedures	19
3.5.1 Two-Point TEACH	19
3.5.2 One-Point TEACH	20
3.6 Sync Master/Slave	21
<b>4 Specifications</b>	22
4.1 Dimensions	23
4.2 Performance Curves—Threaded Barrel Models	24
4.3 Performance Curves—Flush Mount Models	25
<b>5 Abbreviations</b>	27
<b>6 Troubleshooting</b>	29
<b>7 Accessories</b>	30
7.1 Cordsets	30
7.2 Brackets	31
7.3 Aperture Kits—Threaded Barrel Models	32
<b>8 Contact Us</b>	33
<b>9 Banner Engineering Corp. Limited Warranty</b>	34

# 1 Product Description

Class 1 laser CMOS analog sensor with an analog output. Patent pending.

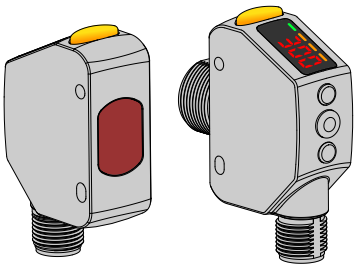

- Reliably detects submillimeter distance changes
- Continuous measurement of challenging targets from dark to reflective, out to 500 mm (threaded barrel models) or 310 mm (flush mount models), depending on model
- Resists mechanical impact, over tightening, and extreme vibration
- Simplified user experience with analog (V or mA) or distance (mm) readout from the angled, four-digit display
- Easy setup with responsive buttons
- Durable and robust construction resists mechanical impact, over tightening, and extreme vibration
- FDA grade stainless steel, rated to IP67, IP68, and IP69K, ECOLAB® certified chemically-resistant materials, and laser marked sensor information withstands aggressive cleaning procedures
- Superior ambient light resistance

For illustration purposes, the threaded barrel model Q4X images are used throughout this document.



**WARNING: Not To Be Used for Personnel Protection**

Never use this device as a sensing device for personnel **protection**. Doing so could lead to serious injury or death. This device does not include the self-checking redundant circuitry necessary to allow its use in personnel safety applications. A sensor failure or malfunction can cause either an energized or de-energized sensor output condition.

## 1.1 Models

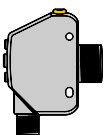
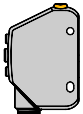
Model	Sensing Range	Output	Connection <sup>1</sup>	
	Q4XTULAF500-Q8	25 mm to 500 mm (0.98 in to 19.68 in)	Analog voltage (0 to 10 V)	
	Q4XTILAF500-Q8		Analog current (4 to 20 mA)	
	Q4XTULAF300-Q8	25 mm to 300 mm (0.98 in to 11.81 in)	Analog voltage (0 to 10 V)	Integral 5-pin M12/Euro-style male quick disconnect (OD)
	Q4XTILAF300-Q8		Analog current (4 to 20 mA)	
	Q4XTULAF100-Q8	25 mm to 100 mm (0.98 in to 3.94 in)	Analog voltage (0 to 10 V)	
	Q4XTILAF100-Q8		Analog current (4 to 20 mA)	
	Q4XFULAF310-Q8	35 mm to 310 mm (1.38 in to 12.20 in)	Analog voltage (0 to 10 V)	
	Q4XFILAF310-Q8		Analog current (4 to 20 mA)	
	Q4XFULAF110-Q8	35 mm to 110 mm (1.38 in to 4.33 in)	Analog voltage (0 to 10 V)	
	Q4XFILAF110-Q8		Analog current (4 to 20 mA)	

## 1.2 Overview

The Q4X Analog Sensor is a Class 1 laser CMOS measuring sensor that uses a 0 to 10 V (4 to 20 mA) output to represent the distance measured.

When the sensor is in Run mode, the display shows the current measurement reading or corresponding analog output value. The size and location of the analog output window can be manually adjusted or the selected TEACH method can be performed.

When the sensor is in Setup mode, all standard operating parameters, including TEACH mode, analog slope, response time, and more can be adjusted, or a factory reset can be performed.

<sup>1</sup> OD models require a mating cordset.

## 1.3 Features

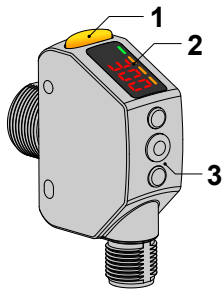

Figure 1. Sensor Features

1. Output Indicator (Amber)
2. Display
3. Buttons

### 1.3.1 Display and Indicators

The display is a 4-digit, 7-segment LED. The main screen is the Run Mode screen, which shows the current distance to the target in millimeters.



Figure 2. Display in Run Mode

1. Stability Indicator (STB = Green)
2. Active TEACH Indicators
  - 2-PT = Two-Point TEACH (Amber)
  - 1-PT = One-Point TEACH (Amber)
3. Display Value Indicator (MM = Amber)

#### Output Indicator

- On—Displayed distance is within the taught analog output window
- Off—Displayed distance is outside of the taught analog output window

#### Active TEACH Indicators (2PT and 1PT)

- 2-PT on—Two-point TEACH mode selected (default)
- 1-PT on—One-point TEACH mode selected

#### Stability Indicator (STB)

- On—Stable signal within the specified sensing range
- Flashing—Marginal signal, the target is outside of the limits of the specified sensing range, or a multiple peak condition exists
- Off—No target detected within the specified sensing range

#### Display Value Indicator (MM)

- On—Display shows the distance in millimeters (default)
- Off—Display shows the analog output value

### 1.3.2 Buttons

Use the sensor buttons (SELECT)(TEACH), (+)(DISP), and (-)(MODE) to program the sensor.

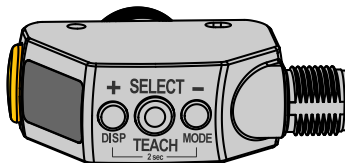

**(SELECT)(TEACH)**

- Press and hold for longer than 2 seconds to start the currently selected TEACH mode (the default is two-point TEACH)
- Press to select menu items in Setup mode

**(-)(MODE)**

- Press to change the distance setting for the 0 V (4 mA) point; press and hold to decrease numeric values
- Press and hold for longer than 2 seconds to enter Setup mode
- Press to navigate the sensor menu in Setup mode

**(+)(DISP)**

- Press to change the distance setting for the 10 V (20 mA) point; press and hold to increase numeric values
- Press and hold for longer than 2 seconds to toggle the display value between the distance and the analog output
- Press to navigate the sensor menu in Setup mode



Note: When navigating the menu, the menu items loop.

## 1.4 Laser **Description** and Safety **Information**

---



**CAUTION:** Use of controls or adjustments or performance of procedures other than those specified herein may result in hazardous radiation exposure. Do not attempt to disassemble this sensor for repair. A defective unit must be returned to the manufacturer.

### Class 1 Lasers

Class 1 lasers are lasers that are safe under reasonably foreseeable conditions of operation, including the use of optical instruments for intrabeam viewing.

COMPLIES WITH 21 CFR 1040.10 AND 1040.11  
EXCEPT FOR DEVIATIONS PURSUANT TO  
LASER NOTICE No. 50, DATED JUNE 24, 2007.  
BANNER ENGINEERING CORP.  
9714 10TH AVENUE NORTH  
MINNEAPOLIS, MN 55441

**CLASS 1  
LASER PRODUCT**

COMPLIES WITH IEC 60825-1:2007

Laser wavelength: 655 nm

Output: < 0.20 mW

Pulse **Duration:** 7  $\mu$ s to 2 ms

## 2 Installation

### 2.1 Install the Safety Label

The safety label must be installed on Q4X sensors that are used in the United States.



Note: Position the label on the cable in a location that has minimal chemical exposure.

1. Remove the protective cover from the adhesive on the label.
2. Wrap the label around the Q4X cable, as shown.
3. Press the two halves of the label together.

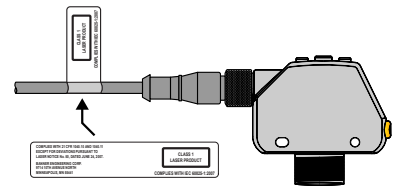

Figure 3. Safety Label Installation

### 2.2 Sensor Orientation

Optimize detection reliability and performance with correct sensor-to-target orientation. To ensure reliable detection, orient the sensor as shown in relation to the target to be detected.

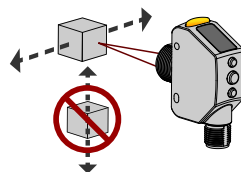

Figure 4. Optimal Orientation of Target to Sensor

See the following figures for examples of correct and incorrect sensor-to-target orientation as certain placements may pose problems for sensing some targets.

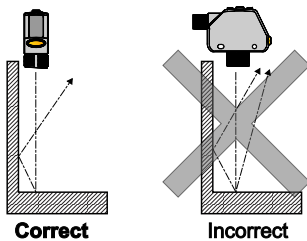

Figure 5. Orientation by a wall

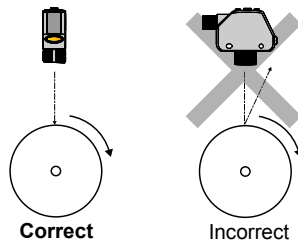

Figure 6. Orientation for a turning object

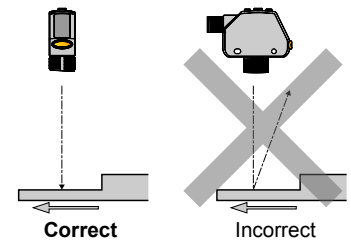

Figure 7. Orientation for a height difference

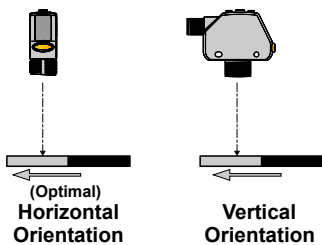

Figure 8. Orientation for a color or luster difference

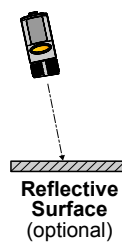

Figure 9. Orientation for highly reflective target<sup>2</sup>

### 2.3 Mount the Sensor

1. If a bracket is needed, mount the sensor onto the bracket.
2. Mount the sensor (or the sensor and the bracket) to the machine or equipment at the desired location. Do not tighten the mounting screws at this time.

<sup>2</sup> Applying tilt to sensor may improve performance on reflective targets. The direction and magnitude of the tilt depends on the application, but a 15° tilt is often sufficient.

3. Check the sensor alignment.
4. Tighten the mounting screws to secure the sensor (or the sensor and the bracket) in the aligned position.

## 2.4 Wiring Diagram

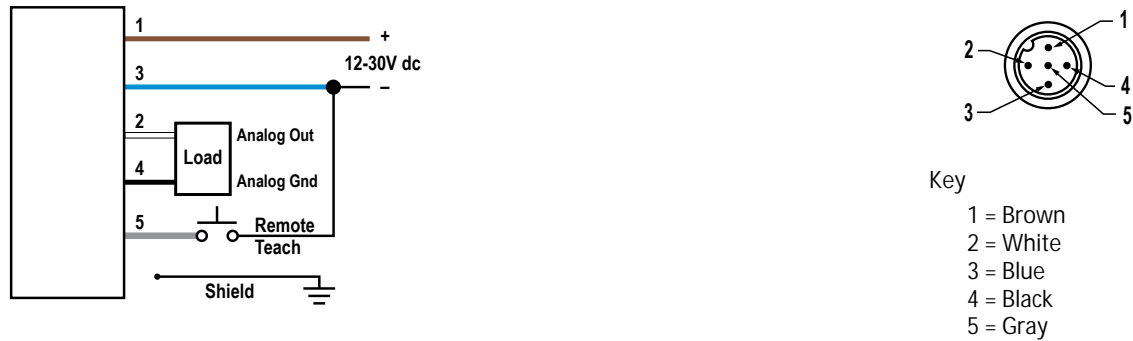

 Note: Open lead wires must be connected to a terminal block.

 Note: The input wire function is user-selectable. The default for the input wire function is off (disabled).

 Note: Shielded cordsets are recommended for all models with quick disconnect fittings. It is recommended that the shield wire be connected to -V dc (the blue wire).

## 2.5 Cleaning and Maintenance

Handle the sensor with care during installation and operation. Sensor windows soiled by fingerprints, dust, water, oil, etc. may create stray light that may degrade the peak performance of the sensor. Blow the window clear using filtered, compressed air, then clean as necessary using water and a lint-free cloth.





## 3 Sensor Programming

Program the sensor using the buttons on the sensor or the remote input (limited programming options).

In addition to programming the sensor, use the remote input to disable the buttons for security, preventing unauthorized or accidental programming changes. See [Locking and Unlocking the Sensor Buttons](#) on page 18 for more information.

### 3.1 Setup Mode

---

1. Access Setup mode and the sensor menu from Run mode by pressing and holding MODE for longer than 2 seconds.
2. Use  and  to navigate through the menu.
3. Press SELECT to select a menu option and access the submenus.
4. Use  and  to navigate through the submenus.
5. Select a submenu option.
  - Press SELECT to select a submenu option and return to the top menu.
  - Press and hold SELECT for longer than 2 seconds to select a submenu option and return immediately to Run mode.

To exit Setup mode and return to Run mode, navigate to **End** and press SELECT.



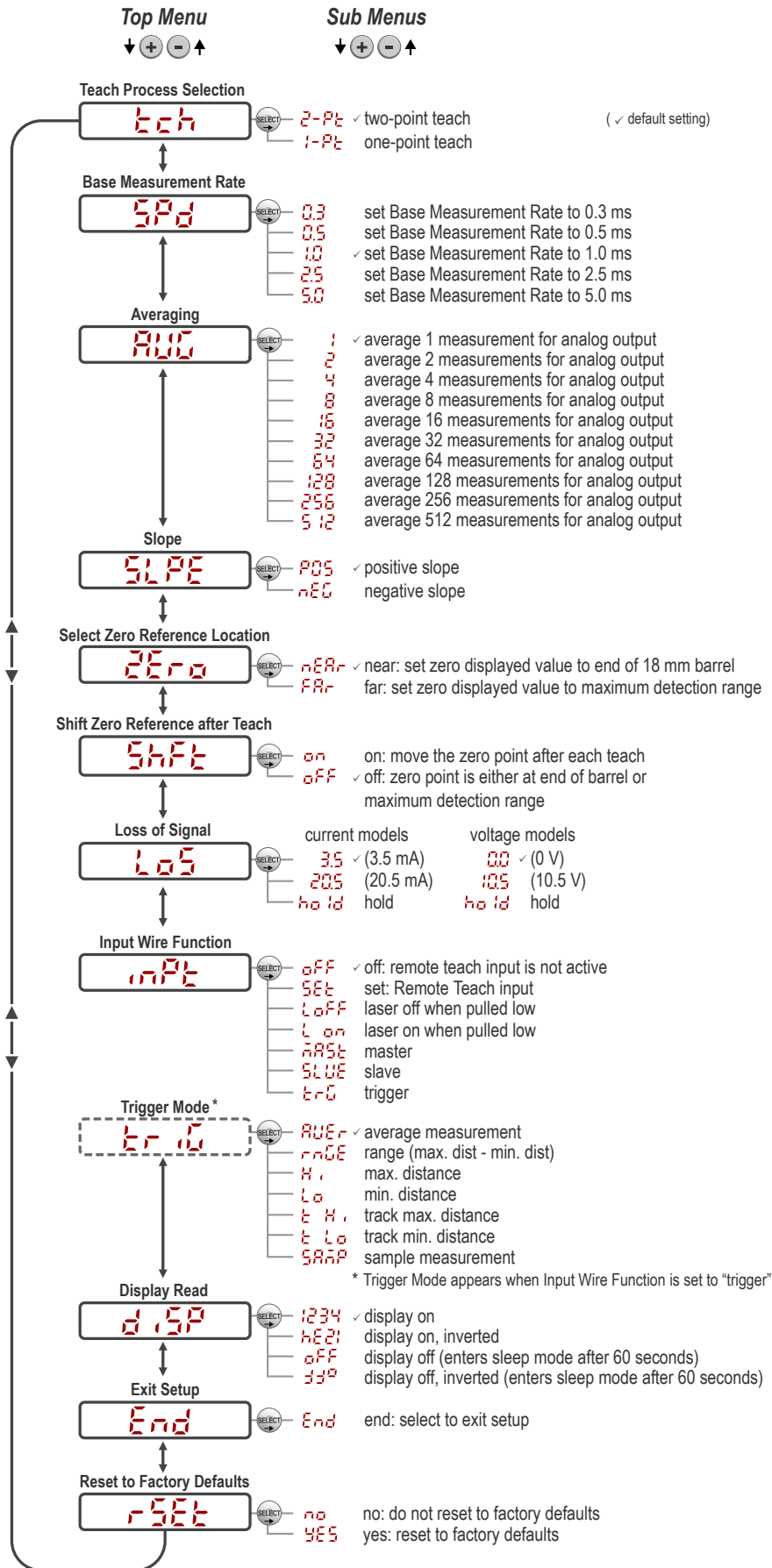

Figure 10. Sensor Menu Map

### 3.1.1 TEACH Menu **TECH**

Use this menu to select the TEACH mode. The default is two-point TEACH.

- **2-PT**—Two-point
- **1-PT**—One-point TEACH

After the TEACH mode is selected, from Run mode, press and hold TEACH for longer than 2 seconds to start the TEACH mode and program the sensor. See [TEACH Procedures](#) on page 19 for additional information and remote input TEACH instructions.

### 3.1.2 Base Measurement Rate **SPD**

Use this menu to select the base measurement rate. The total response speed depends upon the measurement rate setting and the averaging setting. See [Averaging](#) on page 10 for more information.

- **03**—0.3 ms
- **05**—0.5 ms
- **10**—1.0 ms
- **25**—2.5 ms
- **50**—5.0 ms

Table 1: Tradeoffs—Threaded Barrel Models

Base Measurement Rate (ms)	Base Measurement Rate in Sync Mode (ms)	Ambient Light Rejection	Excess Gain—90% white card			
			at 25 mm	at 100 mm	at 300 mm	at 500 mm
0.3	0.5	Disabled	200	100	20	7
0.5	1.0	Enabled	200	100	20	7
1.0	2.0	Enabled	1000	500	100	36 (18)
2.5	5.0	Enabled	2500	1250	250	90 (36)
5.0	10.0	Enabled	5000	2500	500	180 (90)

Table 2: Tradeoffs—Flush Mount Models

Base Measurement Rate (ms)	Base Measurement Rate in Sync Mode (ms)	Ambient Light Rejection	Excess Gain—90% white card		
			at 35 mm	at 110 mm	at 310 mm
0.3	0.5	Disabled	200	100	20
0.5	1.0	Enabled	200	100	20
1.0	2.0	Enabled	1000	500	100
2.5	5.0	Enabled	2500	1250	250
5.0	10.0	Enabled	5000	2500	500

### 3.1.3 Averaging **AUG**

Use this menu to set the number of measurements that are averaged together for the analog output. Increasing the averaging improves repeatability, but increases the total response speed. The default is 1. The filter can be set to 1, 2, 4, 8, 16, 32, 64, 128, 256, or 512. Use the table to determine the total response speed.

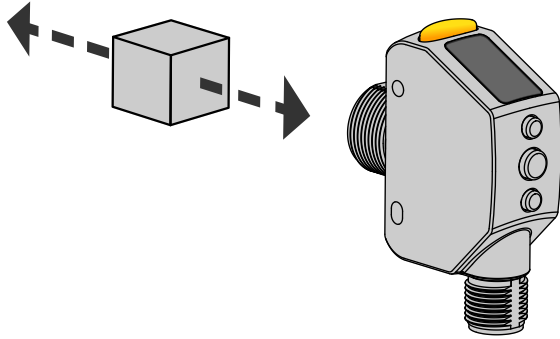
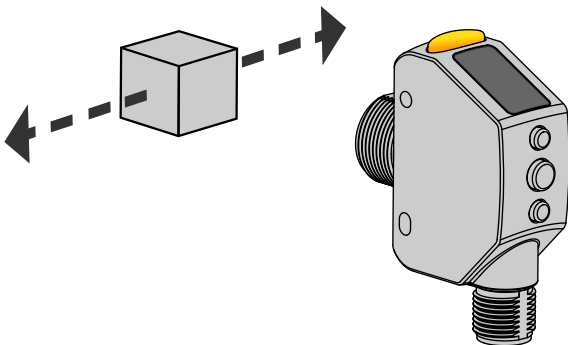

Table 3: Response Speed

Base Measurement Rate	Filter Setting									
	1	2	4	8	16	32	64	128	256	512
0.3 ms	0.5 ms	0.75 ms	1.5 ms	4 ms	8 ms	15 ms	30 ms	60 ms	120 ms	240 ms
0.5 ms	0.5 ms	1 ms	2 ms	5 ms	10 ms	25 ms	50 ms	100 ms	200 ms	350 ms
1 ms	1 ms	3 ms	5 ms	10 ms	20 ms	40 ms	75 ms	150 ms	300 ms	600 ms
2.5 ms	2.5 ms	5 ms	10 ms	25 ms	45 ms	80 ms	160 ms	320 ms	640 ms	1280 ms
5 ms	5 ms	10 ms	20 ms	40 ms	80 ms	160 ms	320 ms	640 ms	1280 ms	2560 ms

Table 4: Lateral Entry Response



Base Measurement Rate	Lateral Entry Response
0.3 ms	1.5 ms
0.5 ms	3 ms
1 ms	10 ms
2.5 ms	25 ms
5 ms	50 ms

When lateral entry needs to be considered, the lateral entry response is added to calculate the total response time.



Note: The Q4X uses a dynamic measurement rate, so these response times are worst-case.

### 3.1.4 Slope **SLPE**

Use this menu to set the slope as positive or negative. This swaps the 0 V and 10 V (4 and 20 mA) values. The default is positive. The slope is defined relative to the zero reference, so if the zero setting is changed from near to far, a slope will be considered positive if the analog output increases as the target becomes closer to the face of the sensor.

- **POS** —the slope is positive
- **NEG** —the slope is negative

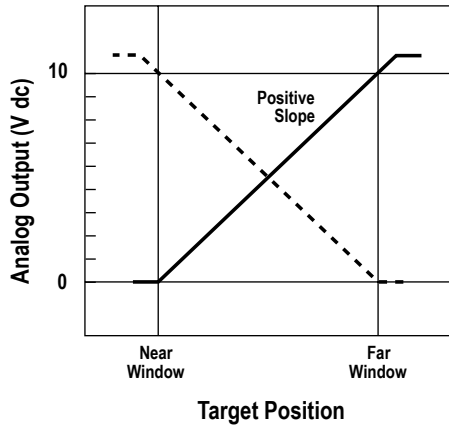

The analog voltage output tracks slightly beyond the upper window limit (up to 10.2 V)

Figure 11. Slope—Voltage Sourcing Models

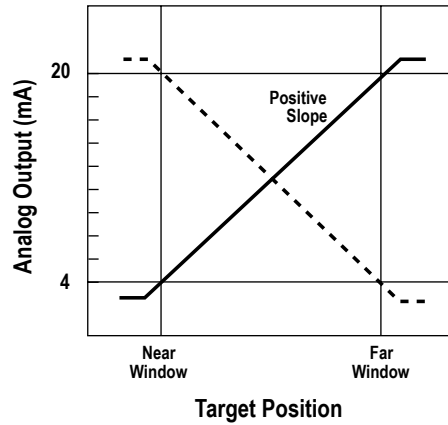

The analog current output tracks slightly beyond each window limit (from 3.8 mA to 20.2 mA)

Figure 12. Slope—Current-Sourcing Models

### 3.1.5 Zero Reference **Location** **Zero**

Use this menu to select the zero reference location. The default is **near**, 0 = the front of the sensor.

- **near** —0 = the front of the sensor; the measurement increases further from the sensor
- **far** —0 = maximum range; the measurement increases closer to the sensor

### 3.1.6 **Shift** the Zero Reference **Location after** a TEACH **Shift**

Use this menu to select whether the sensor shifts the zero reference location based on the last TEACH process. The default is **off**, 0 = the front of the sensor or the maximum range.

- **on** —Shift the zero reference location to one of the taught positions with each TEACH
- **off** —0 = the front of the sensor or the maximum range, depending on the **Zero** setting

This figure illustrates three examples of how changes to the zero and shift settings affect what distance readout is shown on the display when in 2-pt TEACH mode. Changes to the zero setting affect the direction in which the distance increases. Turning the shift setting on sets the taught location as the reference point for any distance measurement. For two-point TEACH, this is the 0 V (4 mA) point. For one-point TEACH, this is the 5 V (12 mA) point.

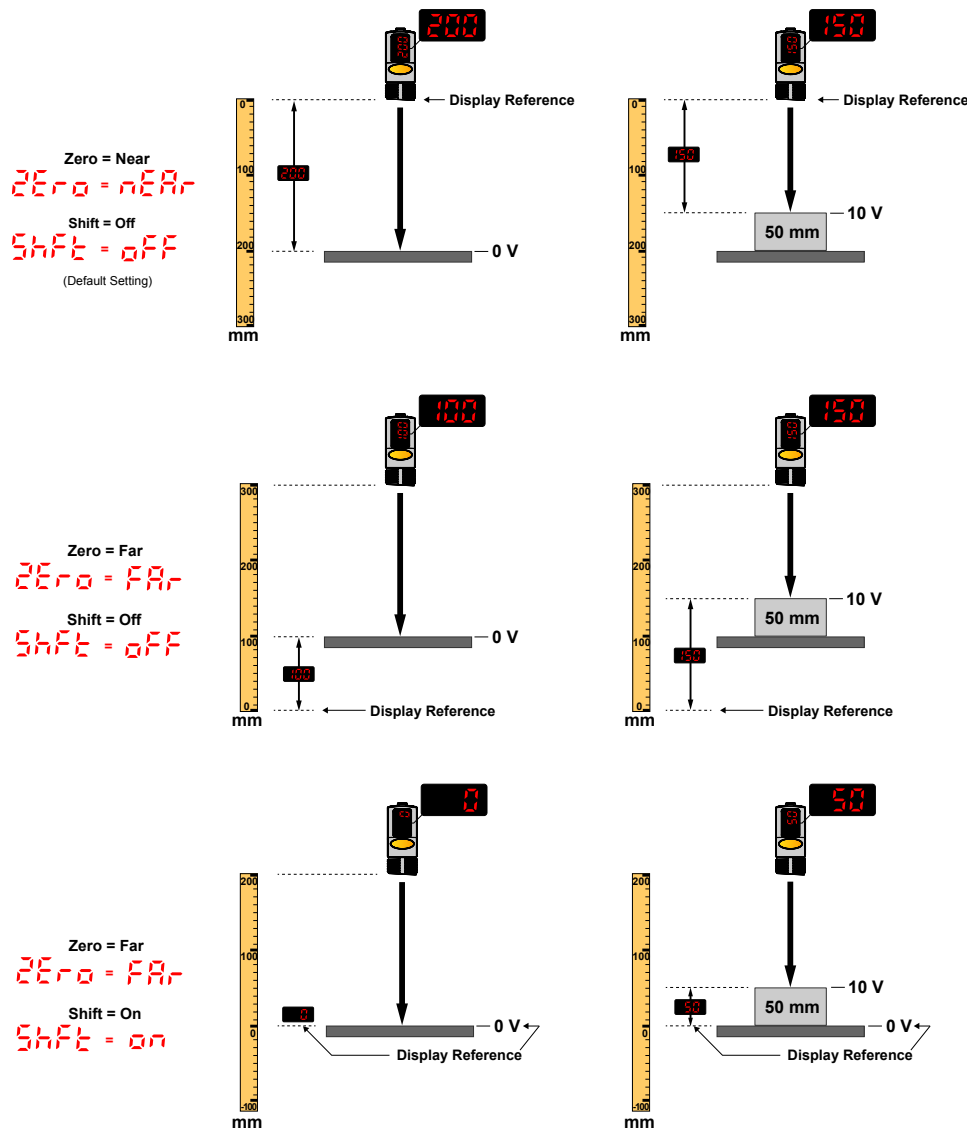

Figure 13. Example Zero and Shift settings

### 3.1.7 Loss of Signal LOS

Use this menu to select the Analog Output value used by the sensor during a loss of signal. When a signal is restored, measurement resumes. The default is 0 V (4 mA).

Option	Description
0 V (4 mA)—default	The Analog Output switches to this value 2 seconds after a loss of signal. When advanced measurements are enabled, the Analog Output is updated to this value immediately upon the release of the trigger input. For Voltage models, this is 0 V (4 mA). (Default)
10.5 V (20.5 mA)	The Analog Output switches to this value 2 seconds after a loss of signal. When advanced measurements are enabled, the Analog Output is updated to this value immediately upon the release of the trigger input. For Voltage models, this is 10.5 V (20.5 mA).
Hold	The Analog Output holds the last value indefinitely during a loss of signal. When advanced measurements are enabled, the last value is held across the triggered measurement periods.

The Range advanced measurement behavior is affected by the Loss of Signal option. For additional information on advanced measurements, see [Trigger](#) on page 14. The Range advanced measurement tracks a maximum and a minimum during the measurement period, and calculates the range as follows:

$$\text{Range} = \text{maximum distance} - \text{minimum distance}$$

If the maximum and/or minimum measurements are outside of the taught range values, the Loss of Signal option determines how the range is calculated.

Option	Sensor Behavior in Range Mode
0 V (4 mA)	If the maximum or minimum measurement is outside of the taught range values, the sensor outputs 0 V (4 mA) to indicate an out of range measurement.
10.5 V (20.5 mA)	If the maximum or minimum measurement is outside of the taught range values, the sensor outputs 10.5 V (20.5 mA) to indicate an out of range measurement.
Hold	The sensor limits the maximum and minimum measurements so that they cannot exceed the taught range values.

### 3.1.8 Input Wire Function **INPT**

Use this menu to select the input wire function. The default is off, ignore all remote input pulses.

- **OFF** —Ignore all remote input pulses
- **SET** —Remote TEACH input
- **LOFF** —Laser off when pulled low
- **LOn** —Laser on when pulled low
- **MAST** —Master sync line output for two-sensor cross-talk avoidance
- **SLVE** —Slave sync line input for two-sensor cross-talk avoidance
- **TRG** —Trigger mode for advanced measurements (see [Trigger](#) on page 14)

To configure sensors for master-slave operation, see [Sync Master/Slave](#) on page 21.

### 3.1.9 Trigger **TRG**

The Trigger option sets the advanced measurement that is calculated when a trigger event is detected on the remote input. The analog output updates with the new advanced measurement on each trigger event. To use these Trigger options, the sensor Input Type option must be set to **TRG**.

Trigger Submenus	Description
Average <b>AVER</b>	The averaged distance since the last trigger event. (default)
Range <b>RNGE</b>	The difference between the maximum and minimum distance since the last trigger event. For additional information on the Range measurement behavior when the maximum or minimum distance is outside of the taught values, see <a href="#">Loss of Signal</a> on page 13.
Maximum <b>H1</b>	The maximum distance since the last trigger event.
Minimum <b>Lo</b>	The minimum distance since the last trigger event.
TrackMax <b>t H1</b>	The maximum distance since the last trigger event. The Analog Output tracks new maximum values during the measurement period.
TrackMin <b>t Lo</b>	The minimum distance since the last trigger event. The Analog Output tracks new minimum values during the measurement period.
Sample <b>SAMP</b>	The current distance at the time of the trigger event. The Analog Output tracks the sample values during the measuring period.

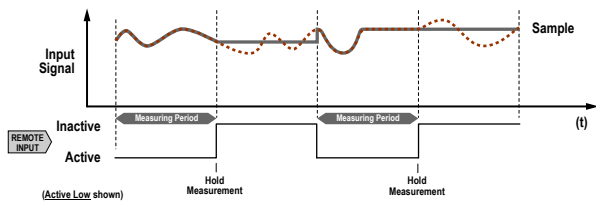

Figure 14. Sample

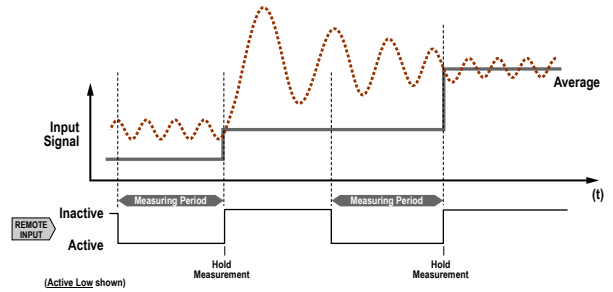

Figure 15. Average

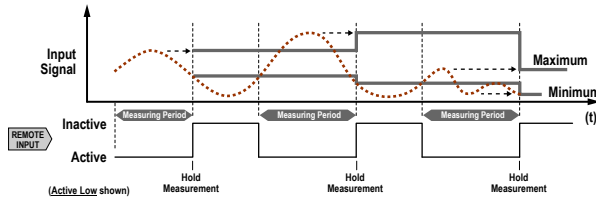

Figure 16. Maximum and Minimum

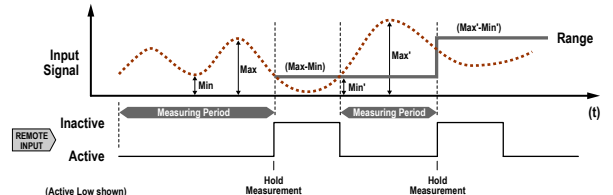

Figure 17. Range

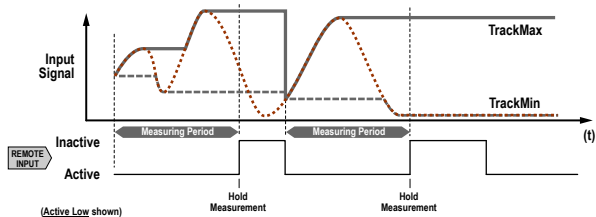

Figure 18. Track Maximum and Track Minimum

### 3.1.10 Display View d.5P

Use this menu to select the display view. The default is right-reading.

- 1234—Right-reading
- 4E21—Inverted
- off —Right-reading and the display enters sleep mode after 60 seconds
- 33° —Inverted and the display enters sleep mode after 60 seconds

When the sensor is in sleep mode, the display wakes with the first button press.

### 3.1.11 Exit Setup Mode End

Navigate to End and press SELECT to exit Setup mode and return to Run mode.

### 3.1.12 Reset to Factory Defaults r5Et



Use this menu to restore the sensor to the factory default settings. See [Factory Default Settings](#) on page 16.

Select no to return to the sensor menu without restoring the defaults. Select yes to apply the factory defaults and return to Run mode.

## Factory Default Settings

Setting	Factory Default
Averaging ( <i>AVG</i> )	<i>1</i>
Base Measurement Rate ( <i>SPd</i> )	<i>1</i> —1 ms
Display View ( <i>d.SP</i> )	<i>1234</i> —Right-reading, no sleep mode
Input Wire Function ( <i>INPt</i> )	<i>OFF</i> —Ignore all remote input pulses If the sensor was reset using the remote input, the sensor remains in <i>SEt</i> mode to allow use of the remote input.
Loss of Signal ( <i>LOS</i> )	<i>00</i> —0 V (4 mA)
Shift the Zero Reference Location after a TEACH ( <i>SHFt</i> )	<i>OFF</i> —0 = the front of the sensor
Slope ( <i>SLOPE</i> )	<i>POS</i> —positive
TEACH Mode ( <i>teCh</i> )	<i>2-Pt</i> —Two-point TEACH
Zero Reference Location ( <i>ZEro</i> )	<i>NEAR</i> —Measurement increases further from sensor

## 3.2 Manual Adjustments

Manually adjust the distance set for the 0 V (4 mA) and 10 V (20 mA) values using the  and  buttons. The available adjustments vary depending on the TEACH mode selected.



### 3.2.1 Manual Adjustments in Two-Point TEACH Mode

Adjust the 10 V (20 mA) Point

- From Run mode, press  to view and adjust the distance associated with the 10 V (20 mA) point. *10.0* displays briefly, then the value slowly flashes indicating it can be changed.



Note: If no changes are made within 8 seconds, the current distance value flashes quickly and the sensor returns to Run mode.

- Press  to move the value up or  to move the value down.



Note: If no additional changes are made within 4 seconds, the current distance value flashes quickly and the sensor returns to Run mode.



- Press Select to confirm the new distance value. The new distance flashes rapidly, the new setting is accepted, and the sensor returns to Run mode.

Adjust the 0 V (4 mA) Point

- Press  to view and adjust the distance associated with the 0 V (4 mA) point. *0.0* flashes briefly, then the value flashes.



Note: If no changes are made within 8 seconds, the current distance value flashes quickly and the sensor returns to Run mode.

- Press  to move the value up or  to move the value down.



Note: If no additional changes are made within 4 seconds, the current distance value flashes quickly and the sensor returns to Run mode.

- Press Select to confirm the new distance value. The new distance value flashes rapidly, the new setting is accepted, and the sensor returns to Run mode.



### 3.2.2 Manual Adjustments in One-Point TEACH Mode

Adjust the 5 V (12 mA) Midpoint

1. From Run mode, press **+** to view and adjust the distance setting associated with the 5 V (12 mA) midpoint (the mid point of the analog span). **5 U** displays briefly, then the value slowly flashes indicating it can be changed.

 Note: If no changes are made within 8 seconds, the current distance value flashes quickly and the sensor returns to Run mode.

2. Press **+** to move the midpoint up or **-** to move the midpoint down.

 Note: If no additional changes are made within 4 seconds, the current distance value flashes quickly and the sensor returns to Run mode.

3. Press Select to confirm the new midpoint. The new midpoint value flashes rapidly, the new setting is accepted, and the sensor returns to Run mode.

Adjust the Analog Window Size

1. Press **-** to view and adjust the SPAN (the analog window size). **SPAN** flashes briefly, then the value flashes.
2. Press **+** to increase the size of the analog window or **-** to decrease the size of the analog window.
3. Press Select to confirm the window size. The new window size flashes rapidly, the new setting is accepted, and the sensor returns to Run mode.

### 3.3 Remote Input

Use the remote input to program the sensor remotely. The remote input provides limited programming options and is Active low. For Active low, connect the gray input wire to ground (0 V dc), with a remote switch connected between the wire and ground. Pulse the remote input according to the diagram and the instructions provided in this manual.

The length of the individual programming pulses is equal to the value T: 0.04 seconds  $\leq$  T  $\leq$  0.8 seconds.

Exit remote programming modes by setting the remote input low for longer than 2 seconds.

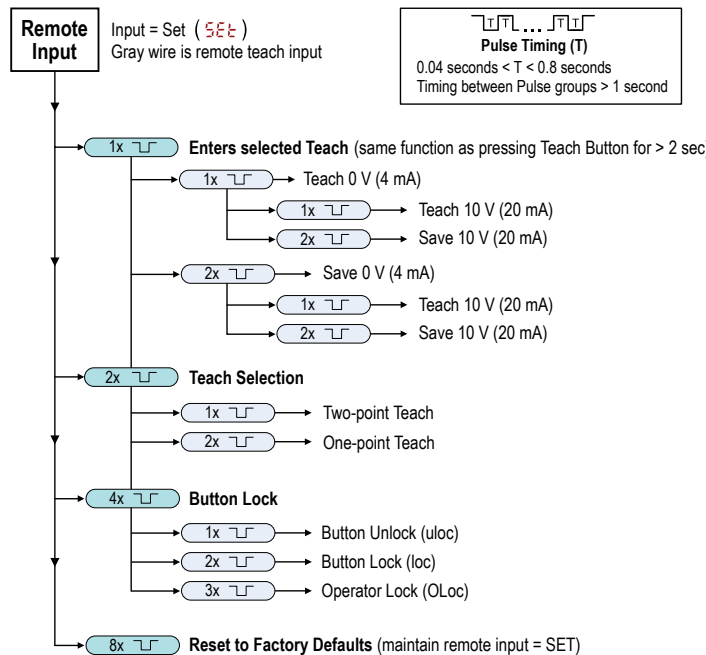
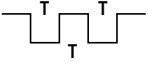



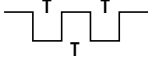

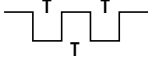

Figure 19. Remote Input Map

#### 3.3.1 Select the TEACH Mode Using the Remote Input

1. Access the TEACH selection.

Action	Result
Double-pulse the remote input.	 <b>teach</b> displays.

2. Select the desired TEACH mode.

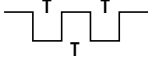
Action	Result						
<table border="1"> <thead> <tr> <th>Pulses</th> <th>TEACH Mode</th> </tr> </thead> <tbody> <tr> <td>1 </td> <td>Two-point TEACH</td> </tr> <tr> <td>2 </td> <td>One-point TEACH</td> </tr> </tbody> </table>	Pulses	TEACH Mode	1 	Two-point TEACH	2 	One-point TEACH	The selected TEACH method displays for a few seconds and the sensor returns to Run mode.
Pulses	TEACH Mode						
1 	Two-point TEACH						
2 	One-point TEACH						

### 3.3.2 Reset to Factory Defaults Using the Remote Input



Eight-pulse the remote input to apply the factory defaults and return to Run mode.



Note: The input wire function remains at remote teach input ( **SET** ).

### 3.4 Locking and Unlocking the Sensor **Buttons**

Use the lock and unlock feature to prevent unauthorized or accidental programming changes. Three settings are available:

- **wloc** —The sensor is unlocked and all settings can be modified (default).
- **loc** — The sensor is locked and no changes can be made.
- **oloc** —The value associated with 0 V (4 mA) and 10 V (20 mA) can be changed by teaching or manual adjustment, but no sensor settings can be changed through the menu.

When in **loc** mode, **loc** displays when the (SELECT)(TEACH) button is pressed. The analog point displays when (+)(DISP) or (-)(MODE) are pressed, but **loc** displays if the buttons are pressed and held.

When in **oloc** mode, **loc** displays when (+)(DISP) or (-)(MODE) are pressed and held. To access the manual adjust options, briefly press and release (+)(DISP) or (-)(MODE). To enter TEACH mode, press the (SELECT)(TEACH) button and hold for longer than 2 seconds.

#### Button Instructions

To enter **loc** mode, hold **+** and press **-** four times. To enter **oloc** mode, hold **+** and press **-** seven times. Holding **+** and pressing **-** four times unlocks the sensor from either lock mode and the sensor displays **wloc**.

#### Remote Input Instructions

1. Access the remote input.

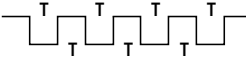
Action	Result
Four-pulse the remote input.	 The sensor is ready to have the button state defined and <b>btn</b> displays.

2. Lock or unlock the sensor buttons.

Action		Result
Single-pulse the remote input to unlock the sensor.		<b>uLoc</b> displays and the sensor returns to Run mode.
Double-pulse the remote input to lock the sensor.		<b>Loc</b> displays and the sensor returns to Run mode.
Triple-pulse the remote input to apply the operator lock to the sensor		<b>OLoc</b> displays and the sensor returns to Run mode

### 3.5 TEACH Procedures

Use the following procedures to teach the sensor.

To cancel a TEACH procedure, press TEACH for longer than 2 seconds, or hold the remote input low for longer than 2 seconds. **Err** momentarily displays when a TEACH procedure is canceled.

#### 3.5.1 Two-Point TEACH **2-Pt**

Two-point TEACH sets the distance values associated with 0 V and 10 V (4 mA and 20 mA) based on taught target distances.

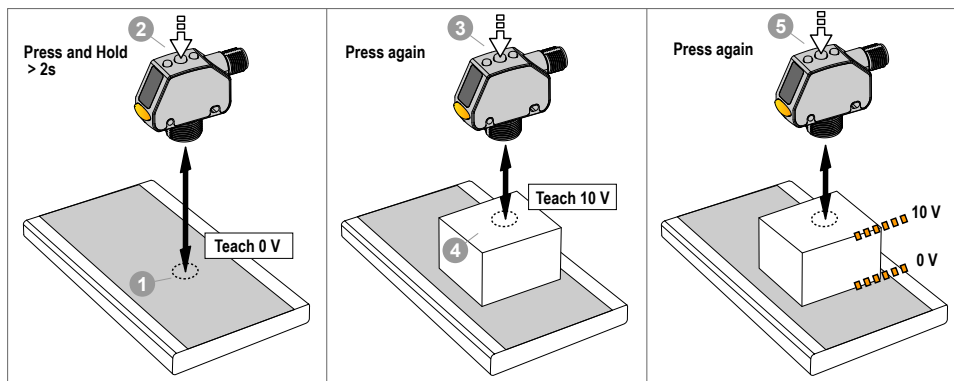

Figure 20. Two-Point TEACH



Note: The sensor must be set to **teCh = 2-Pt** to use the following instructions.



Note: To program the sensor using remote input, remote input must be enabled ( **inPt = 5Et** ).

1. Present the target.

Method	Action	Result
Push <b>Button</b>	Present the first target. The sensor-to-target distance must be within the sensor's range.	The target's measurement value displays.
Remote Input		

2. Start the TEACH mode.

Method	Action	Result
Push <b>Button</b>	Press and hold TEACH for longer than 2 seconds.	<b>5Et</b> and <b>0 V</b> flash alternately on the display. The 2-Pt indicator flashes.
Remote Input	Single-pulse the remote input.	

3. Teach the sensor.

Method	Action	Result
Push <b>Button</b>	Press TEACH to teach the target.	The measurement value flashes briefly, and the sensor is taught the first target. <b>SET</b> and <b>10 U</b> flash alternately on the display. The 2-Pt indicator flashes.
Remote Input	Single-pulse the remote input. 	

It is possible to skip teaching the 0 V (4 mA) point and continue to use the existing setting. When using the push button, hold  for four seconds. The sensor displays SAVE and then flashes the existing value. When using the remote input, double-pulse the remote input.

4. Present the target.

Method	Action	Result
Push <b>Button</b>	Present the second target. The sensor-to-target distance must be within the sensor's range.	<b>SET</b> and <b>10 U</b> flash alternately on the display. The 2-Pt indicator flashes.
Remote Input		

5. Teach the sensor.

Method	Action	Result
Push <b>Button</b>	Press TEACH to teach the target.	The new switch point flashes rapidly and the sensor returns to Run mode.
Remote Input	Single-pulse the remote input. 	



Note: If the same target is taught both times, **Lo** and **SPAN** flash alternately on the display, the 10 V (20 mA) value is automatically adjusted to maintain the minimum window size, the new distance quickly flashes four times, and the sensor returns to Run mode.

It is possible to skip teaching the 10 V (20 mA) point and continue to use the existing setting. When using the push button, hold  for four seconds. The sensor displays SAVE and then flashes the existing value. When using the remote input, double-pulse the remote input.

### 3.5.2 One-Point TEACH **1-Pt**

One-point TEACH mode defines the span of the analog output. One-point TEACH also defines the 5 V (12 mA) midpoint of the analog output to center the analog output around a reference target position.

Refer to [Manual Adjustments in One-Point TEACH Mode](#) on page 17 for more information.

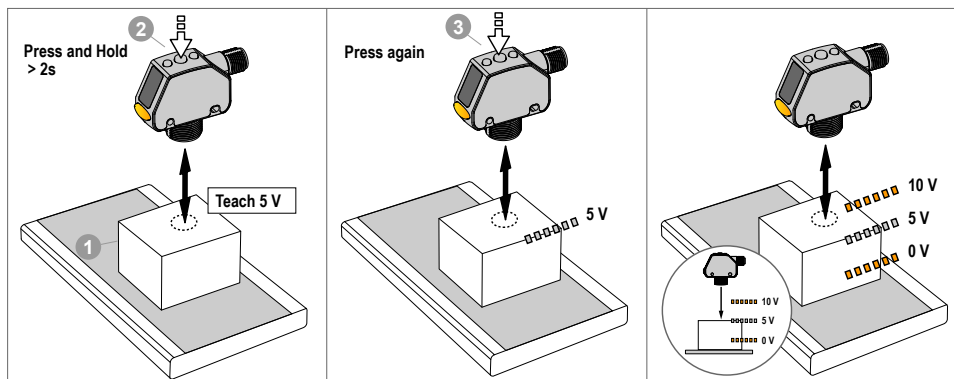

Figure 21. One-Point Window



Note: The sensor must be set to **teach = 1-Pt** to use the following instructions.



Note: To program the sensor using remote input, remote input must be enabled ( **1-Pt = SET** ).

## 1. Present the target.

Method	Action	Result
Push <b>Button</b>	Present the first target. The sensor-to-target distance must be within the sensor's range.	The target's measurement value displays.
Remote Input		

## 2. Start the TEACH mode.

Method	Action	Result
Push <b>Button</b>	Press and hold TEACH for longer than 2 seconds.	<b>SET</b> and <b>S U</b> flash alternately on the display. The 1-Pt indicator flashes.
Remote Input	No action required.	N/A

## 3. Teach the sensor.

Method	Action	Result
Push <b>Button</b>	Press TEACH to teach the target.	The measurement value flashes briefly, and the sensor returns to Run mode.
Remote Input	Single-pulse the remote input. 	

### 3.6 Sync Master/Slave

Two Q4X sensors may be used together in a single sensing application. To eliminate crosstalk between the two sensors, configure one sensor to be the master and one to be the slave. In this mode, the sensors alternate taking measurements and the response speed doubles.



**Important:** The master sensor and the slave sensor must be programmed for the same Base Response Speed setting. The master sensor and slave sensor must share a common power source.

1. Configure the first sensor as the master; navigate: **MPt > MAST**.
2. Configure the second sensor as the slave; navigate: **MPt > SLVE**.
3. Connect the gray (input) wires of the two sensors together.

# 4 Specifications

**Sensing Beam**

Visible red Class 1 laser, 655 nm

**Supply Voltage (Vcc)**

12 to 30 V dc

**Power and Current Consumption**, exclusive of load

< 675 mW

**Sensing Range—Threaded Barrel Models**

500 mm models: 25 mm to 500 mm (0.98 in to 19.68 in)

300 mm models: 25 mm to 300 mm (0.98 in to 11.81 in)

100 mm models: 25 mm to 100 mm (0.98 in to 3.94 in)

**Sensing Range—Flush Mount Models**

310 mm models: 35 mm to 310 mm (1.38 in to 12.20 in)

110 mm models: 35 mm to 110 mm (1.38 in to 4.33 in)

**Analog Output Configuration**

0 to 10 V or 4 to 20 mA, depending on model

**Output Rating**

Analog Voltage Outputs (Q4X..U Models): 2.5 kOhm minimum load resistance

Analog Current Outputs (Q4X..I Models): 1 kOhm maximum load resistance at 24 V; maximum load resistance = [(Vcc - 4.5)/0.02 Ω]

**Remote Input**

Allowable Input Voltage Range: 0 to Vcc

**Active Low** (internal weak pullup—sinking current): Low State < 2.0 V at 1 mA max.

**Supply Protection Circuitry**

Protected against reverse polarity and transient overvoltages

**Analog Resolution—Threaded Barrel Models**

300 mm and 500 mm models:

25 mm to 100 mm: < 0.3 mm

100 mm to 300 mm: < 1 mm

500 mm models only: 300 to 500 mm: < 1.75 mm

100 mm models: 25 mm to 100 mm: < 0.15 mm

**Analog Resolution—Flush Mount Models**

310 mm models:

35 mm to 110 mm: < 0.3 mm

110 mm to 310 mm: < 1 mm

110 mm models: 35 mm to 110 mm: < 0.15 mm

**Beam Spot Size—300/310 mm and 500 mm Models**

Table 5: Beam Spot Size—300/310 mm and 500 mm Models

Distance (mm)		Size (Horizontal × Vertical)
Threaded Barrel Models	Flush Mount Models	
25	35	2.6 mm × 1.0 mm
150	160	2.3 mm × 0.9 mm
300	310	2.0 mm × 0.8 mm
500	-	1.9 mm × 1.0 mm

**Analog Linearity**

Analog linearity performance matches accuracy performance curve (see [Performance Curves—Threaded Barrel Models](#) on page 24 and [Performance Curves—Flush Mount Models](#) on page 25).

**Response Speed**

Total response speed varies from 0.5 ms to 2560 ms, depending on base measurement rate and averaging settings.

See [Averaging](#) on page 10 for more information.

**Delay at Power Up**

< 750 ms

**Ambient Light Immunity**

> 5,000 lux at 300 mm

> 2,000 lux at 500 mm

**Maximum Torque**

Side **mounting**: 1 N·m (9 in-lbs)

Nose **mounting**: 20 N·m (177 in-lbs)

**Connector**

Integral 5-pin M12/Euro-style male quick disconnect (QD)

**Construction**

Housing: 316 L stainless steel

Lens cover: PMMA acrylic

Lightpipe and display window: polysulfone

**Chemical Compatibility**

Compatible with commonly used acidic or caustic cleaning and disinfecting chemicals used in equipment cleaning and sanitation. ECOLAB® certified.

Compatible with typical cutting fluids and lubricating fluids used in machining centers

**Application Note**

For optimum performance, allow 10 minutes for the sensor to warm up

**Beam Spot Size—100/110 mm Models**

Table 6: Beam Spot Size—100/110 mm Models

Distance (mm)		Size (Horizontal × Vertical)
Threaded Barrel Models	Flush Mount Models	
25	35	2.4 mm × 1.0 mm
50	60	2.2 mm × 0.9 mm
100	110	1.8 mm × 0.7 mm

**Environmental Rating**

IEC IP67 per IEC60529

IEC IP68 per IEC60529

IEC IP69K per DIN40050-9

**Shock**

MIL-STD-202G, Method 213B, Condition I (100G 6x along X, Y and Z axes, 18 total shocks), with sensor operating

**Vibration**

MIL-STD-202G, Method 201A (10 Hz to 60 Hz, 0.06 inch (1.52 mm) double amplitude, 2 hours each along X, Y and Z axes), with sensor operating

**Storage Temperature**

-25 °C to +75 °C (-13 °F to +167 °F)

**Operating Conditions**

35% to 95% relative humidity

Vcc	Min. Ambient Temp (°C)	Max. Ambient Temp (°C)	
	All Models	Q4X..U (0–10V)	Q4X..I (4–20 mA)*
12	-10	50	50
24			45
30			40

\* For 4–20 mA models only: Max. Ambient Sensor Temp (°C) = 50 - (Vcc - 12)/2

Required Overcurrent Protection



WARNING: Electrical connections must be made by qualified personnel in accordance with local and national electrical codes and regulations.

Overcurrent protection is required to be provided by end product application per the supplied table.

Overcurrent protection may be provided with external fusing or via Current Limiting, Class 2 Power Supply.

Supply wiring leads < 24 AWG shall not be spliced.

For additional product support, go to [www.bannerengineering.com](http://www.bannerengineering.com).

Supply Wiring (AWG)	Required Overcurrent Protection (Amps)
20	5.0
22	3.0
24	2.0
26	1.0
28	0.8
30	0.5

Certifications



Class 2 power

UL Environmental Rating: Type 1



chemical compatibility certified

ECOLAB is a registered trademark of Ecolab USA Inc. All rights reserved.

4.1 Dimensions

All measurements are listed in millimeters [inches], unless noted otherwise.

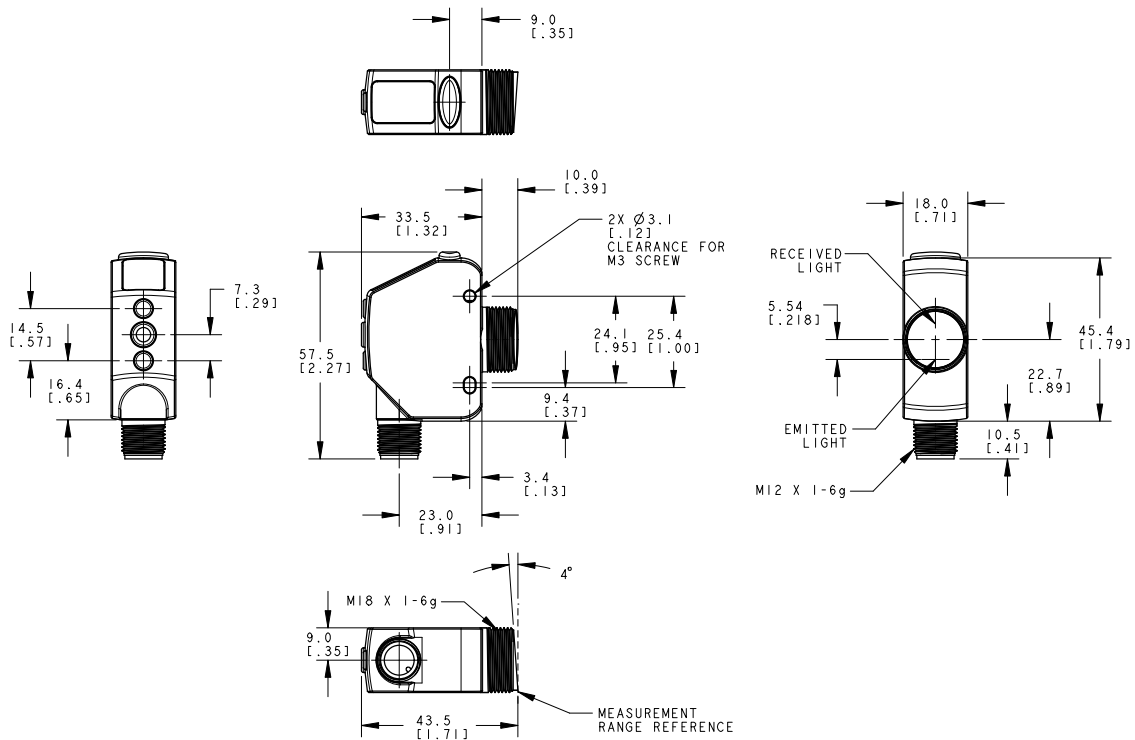

Figure 22. Threaded Barrel Models

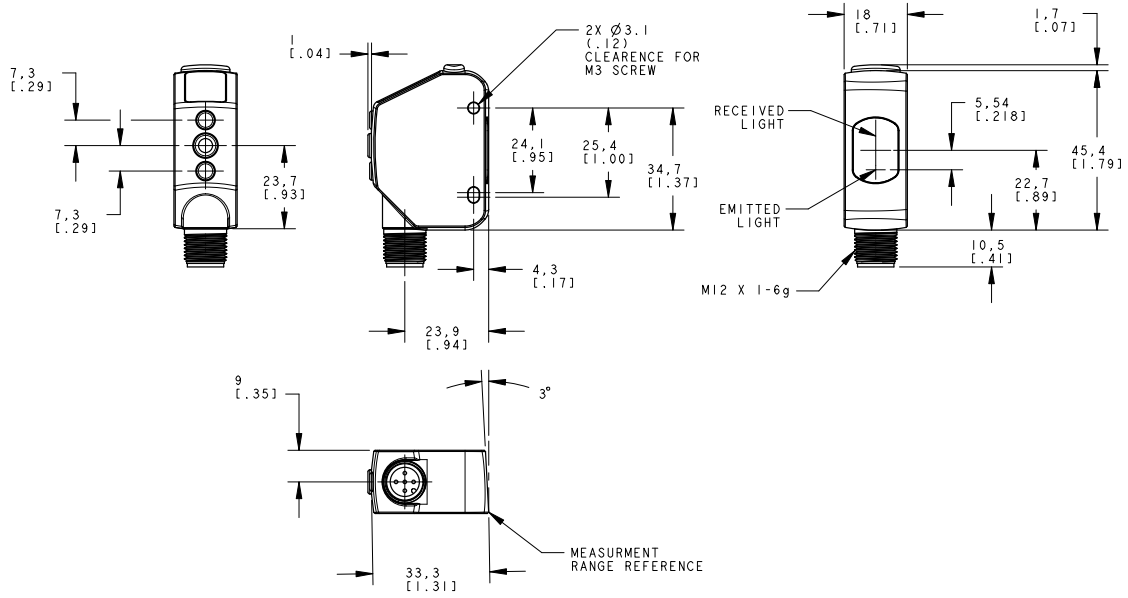
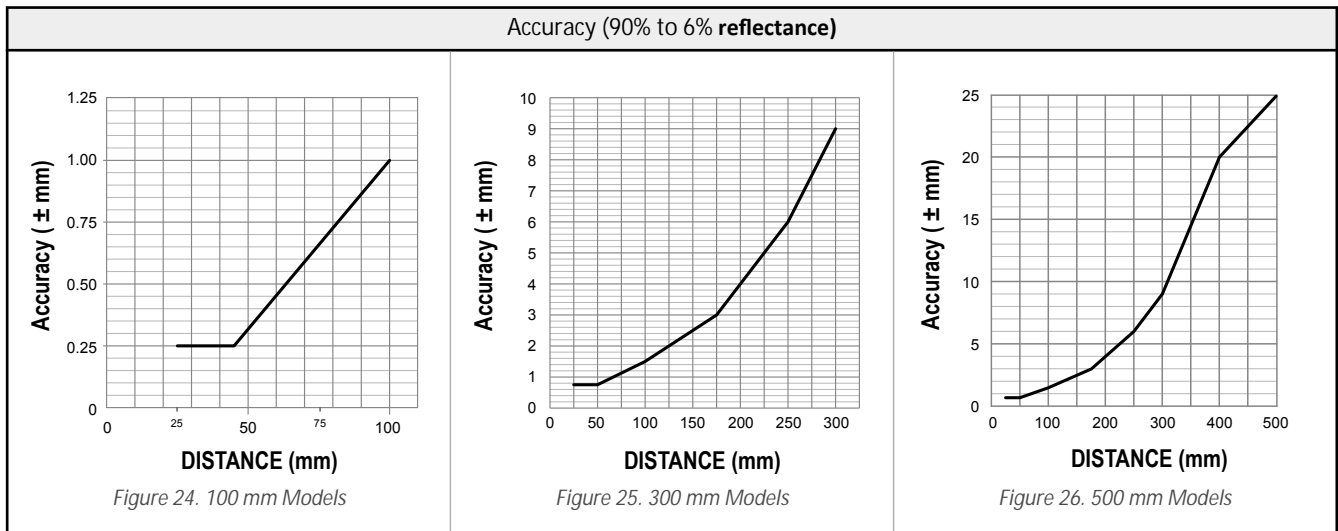
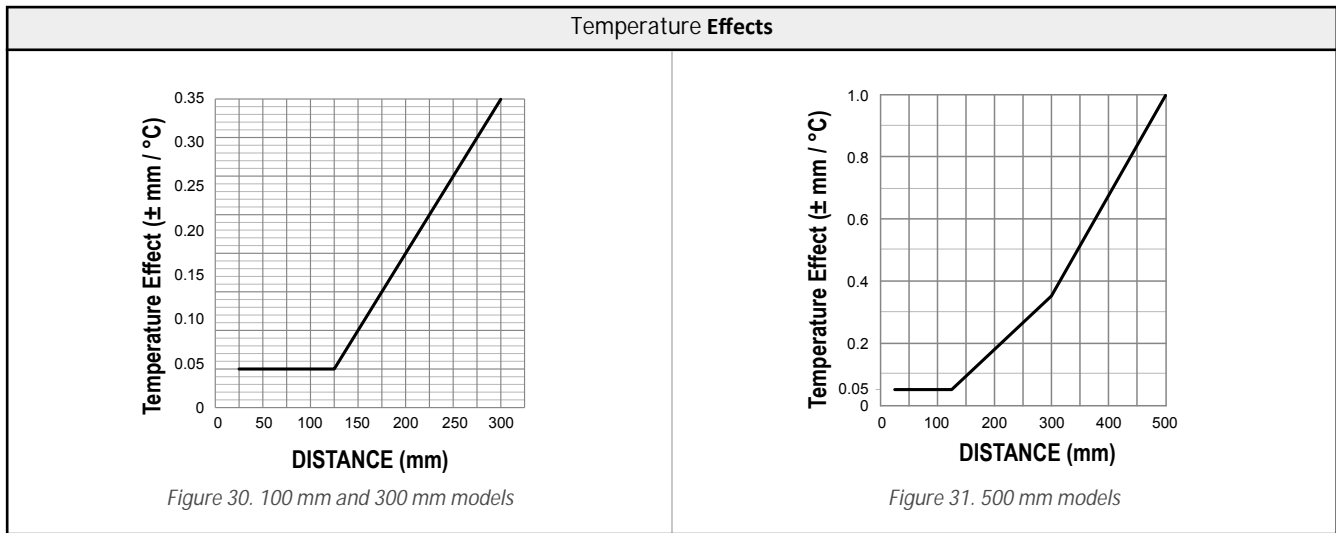
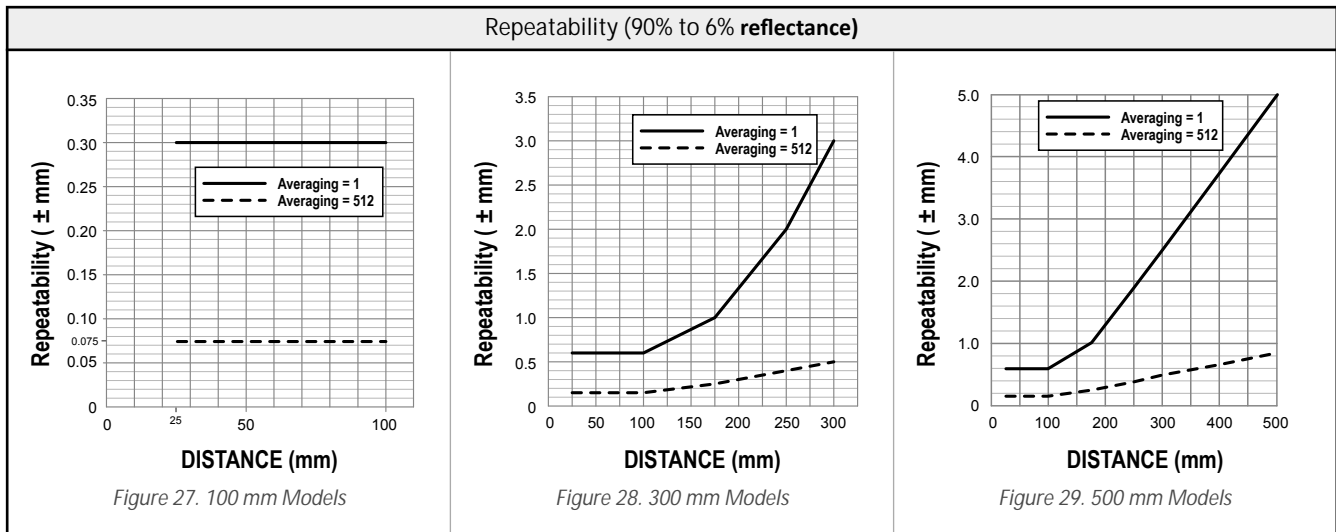

Figure 23. Flush Mount Models

#### 4.2 Performance Curves—Threaded Barrel Models







### 4.3 Performance Curves—Flush Mount Models

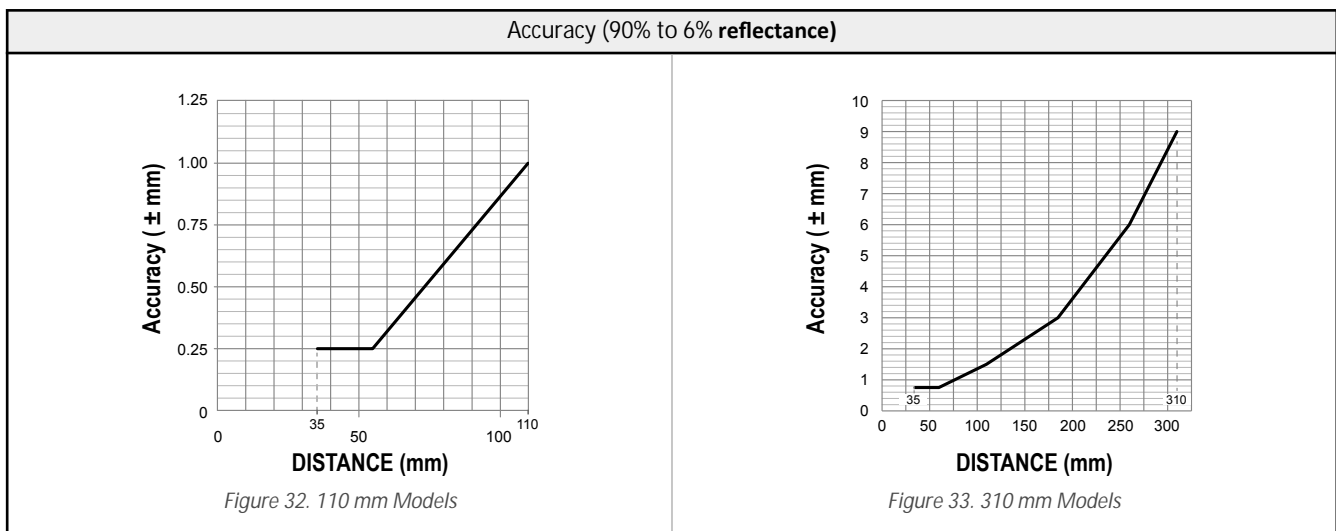

Repeatability (90% to 6% reflectance)

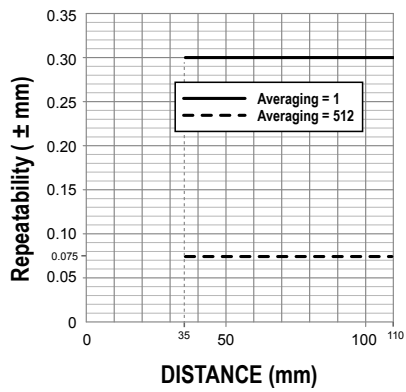

Figure 34. 110 mm Models

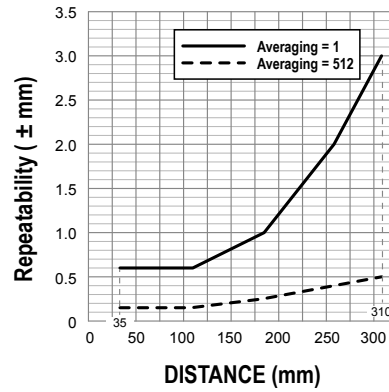
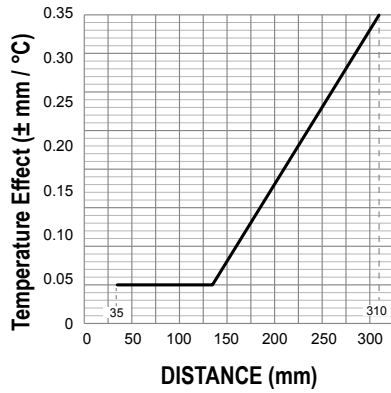

Figure 35. 310 mm Models

Temperature Effects



## 5 Abbreviations

The following table describes the abbreviations used on the sensor display and in this manual.

Abbreviation	Description
----	No valid signal in range
1-Pt	One-point TEACH
2-Pt	Two-point TEACH
Avg	Average—Trigger output of Average measurement value
bot	Bottom
btn	Button
ENCL	Cancel
disP	Display read
dist	Distance
End	End—exit the sensor menu
FAR-	Far zero reference location—the maximum range is 0 and the measurement increase as the target moves closer to the sensor
FLtr	Filter
Hi	Trigger output of maximum measurement value
Hold	Hold the last value
inPt	Input wire function
Lo	Trigger output of minimum measurement value
Loc	Lock/locked
LoFF	Laser off
LOS	Loss of signal
mA	milliAmp
MASt	Master
Min	Min
NEAR-	Near zero reference location—the end of the barrel is 0 and the measurement increase as the target moves further away from the sensor
NEG	Negative slope
OLoc	Allows teaching and adjusting 0 V and 10 V (4 mA and 20 mA) settings, while locking out access to other sensor settings.
POS	Positive slope
ranGE	Range—Hi to Lo
rSEt	Reset to factory defaults
SAMP	Sample—Trigger output of a sampled measurement value
SEt	Input wire = remote teach function

Abbreviation	Description
SHFt	Shift the Zero Reference Location after a TEACH
SLVE	Slave
SPAN	Span—analog window size
SPd	Response speed
tch	TEACH process selection
t H.	Trigger setting for tracking maximum measurement value
t Lo	Trigger setting for tracking minimum measurement value
t r 0	Trigger
t r 0	Trigger—Set the trigger type
U	Volt
uloc	Unlock/unlocked
uuuu	Saturated signal (too much light)
ZEro	Zero—select the zero reference location

## 6 Troubleshooting

Table 7: Troubleshooting Codes

Code	Description	Resolution
----	No valid signal in range	Reposition the sensor or the target
Lo SPAn	The adjusted or taught window size is smaller than the minimum window size.	The sensor automatically adjusts the window size to maintain the minimum window and completes the adjustment or the TEACH
rAnGE	The distance being taught is outside of the valid sensing range	Present a target within the sensor's range and re-TEACH.
uuuu	The signal is saturated (too much light)	Reposition the sensor or the target to increase the detection distance, or increase the angle of incidence between the sensor and the target
End	The adjusted or taught end point is between the other end point and the end of range. There is insufficient space to create the minimum window size.	TEACH or adjust the end points to maintain the minimum window size within the sensing range.

Table 8: Error Codes

Code	Description	Resolution
ErrE	EEPROM fault	Contact Banner Engineering to resolve
ErrL	Laser fault	Contact Banner Engineering to resolve
ErrC	Output short-circuited	Check the wiring for an electrical short circuit and to ensure that the wiring is correct
ErrS	System fault	Contact Banner Engineering to resolve

# 7 Accessories

## 7.1 Cordsets

All measurements are listed in millimeters, unless noted otherwise.

### Standard Cordsets

Cable: PVC jacket, PUR (polyurethane) connector body, nickel-plated brass coupling nut  
 Environmental **Rating:** IEC IP67

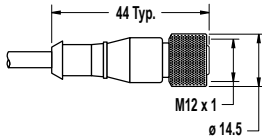
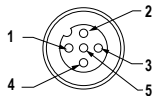
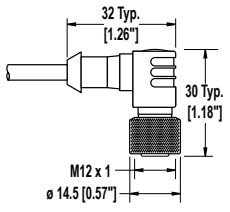
5-Pin Threaded M12/Euro-Style Cordsets—with Shield				
Model	Length	Style	Dimensions	Pinout (Female)
MQDEC2-506	1.83 m (6 ft)	Straight		 <p>1 = Brown                      2 = White                      3 = Blue                      4 = Black                      5 = Gray</p>
MQDEC2-515	4.57 m (15 ft)			
MQDEC2-530	9.14 m (30 ft)			
MQDEC2-550	15.2 m (50 ft)			
MQDEC2-506RA	1.83 m (6 ft)	Right-Angle		
MQDEC2-515RA	4.57 m (15 ft)			
MQDEC2-530RA	9.14 m (30 ft)			
MQDEC2-550RA	15.2 m (50 ft)			

### 5-Pin Threaded M12/Euro-Style Cordsets—Washdown Stainless Steel

Cable: PVC jacket and over-mold, EPDM o-ring, 316L coupling nut  
 Environmental **Rating:** IEC IP69K

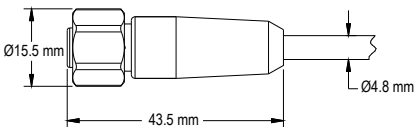
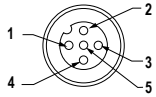
5-Pin Threaded M12/Euro-Style Cordsets—Washdown Stainless Steel				
Model	Length	Style	Dimensions	Pinout (Female)
MQDC-WDSS-0506	1.83 m (6 ft)	Straight		 <p>1 = Brown                      2 = White                      3 = Blue                      4 = Black                      5 = Gray</p>
MQDC-WDSS-0515	4.57 m (15 ft)			
MQDC-WDSS-0530	9.14 m (30 ft)			

### 5-Pin Threaded M12/Euro-Style Cordsets—Washdown, with Shield

Cable: Polypropylene jacket and connector body, stainless steel coupling nut  
 Environmental **Rating:** IEC IP68

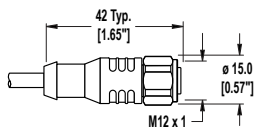
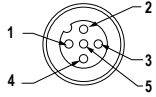
5-Pin Threaded M12/Euro-Style Cordsets—Washdown, with Shield				
Model	Length	Style	Dimensions	Pinout (Female)
MQDCWD-506	1.83 m (6 ft)	Straight		 <p>1 = Brown                      2 = White                      3 = Blue                      4 = Black                      5 = Gray</p>
MQDCWD-530	9.14 m (30 ft)			

## 7.2 Brackets

All measurements are listed in millimeters, unless noted otherwise.

### SMBQ4X..

- Swivel bracket with tilt and pan movement for precision adjustment
- Easy sensor mounting to extruded rail T-slots
- Metric and inch size bolts available
- Side mounting of some sensors with the 3 mm screws included with the sensor

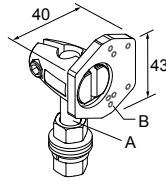

B = 7 × M3 × 0.5

Model	Bolt Thread (A)
SMBQ4XFA	3/8 - 16 × 2 1/4 in
SMBQ4XFAM10	M10 - 1.5 × 50
SMBQ4XFAM12	n/a; no bolt included. Mounts directly to 12 mm (1/2 in) rods

### SMB18FA..

- Swivel bracket with tilt and pan movement for precision adjustment
- Easy sensor mounting to extruded rail T-slots
- Metric and inch size bolts available
- 18 mm sensor mounting hole

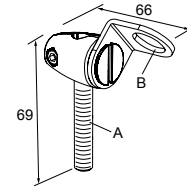

Hole size: B=Ø 18.1

Model	Bolt Thread (A)
SMB18FA	3/8 - 16 × 2 in
SMB18FAM10	M10 - 1.5 × 50
SMB18FAM12	n/a; no bolt included. Mounts directly to 12 mm (1/2 in) rods

### SMB18A

- Right-angle mounting bracket with a curved slot for versatile orientation
- 12-ga. stainless steel
- 18 mm sensor mounting hole
- Clearance for M4 (#8) hardware

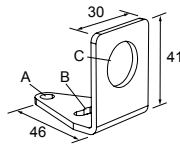

Hole center spacing: A to B = 24.2

Hole size: A = Ø 4.6, B = 17.0 × 4.6, C = Ø 18.5

### SMBAMS18P

- Flat SMBAMS series bracket with 18 mm hole
- Articulation slots for 90+° rotation
- 12-ga. (2.6 mm) cold-rolled steel

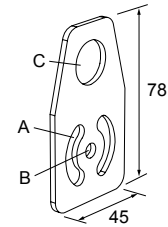

Hole center spacing: A = 26.0, A to B = 13.0

Hole size: A = 26.8 × 7.0, B = Ø 6.5, C = Ø 19.0

### SMBAMS18RA

- Right-angle SMBAMS series bracket with 18 mm hole
- Articulation slots for 90+° rotation
- 12-ga. (2.6 mm) cold-rolled steel

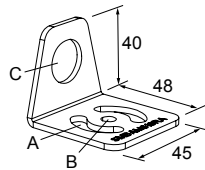

Hole center spacing: A = 26.0, A to B = 13.0

Hole size: A = 26.8 × 7.0, B = Ø 6.5, C = Ø 19.0

## 7.3 Aperture Kits—Threaded Barrel Models

### APG18S

Kit with glass lens to protect plastic sensor lens from chemical environments and weld splatter damage.

Used with S18, M18, T18, TM18, and Q4X

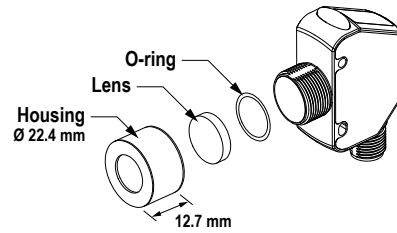

#### Additional Information

- Borosilicate glass window protects the PMMA window from weld splatter and chemicals
- Adds 4.8 mm to the length of the threaded barrel
- Reduces excess gain by 30%; increase the response time to restore excess gain



# 8 Contact Us

## Corporate Headquarters

Address:  
Banner Engineering Corporate  
9714 Tenth Avenue North  
Minneapolis, Minnesota 55441, USA

Phone: +1 763 544 3164  
Website: [www.bannerengineering.com](http://www.bannerengineering.com)

## Europe

Address:  
Banner Engineering EMEA  
Park Lane Culliganlaan 2F  
Diegem B-1831, Belgium

Phone: +32 (0)2 456 0780  
Website: [www.bannerengineering.com/eu](http://www.bannerengineering.com/eu)  
Email: [mail@bannerengineering.com](mailto:mail@bannerengineering.com)

## Turkey

Address:  
Banner Engineering Turkey  
Barbaros Mah. Uphill Court Towers A Blok D:49  
34746 Batı Ataşehir İstanbul Türkiye

Phone: +90 216 688 8282  
Website: [www.bannerengineering.com.tr](http://www.bannerengineering.com.tr)  
Email: [turkey@bannerengineering.com.tr](mailto:turkey@bannerengineering.com.tr)

## India

Address:  
Banner Engineering India Pune Head Quarters  
Office No. 1001, 10th Floor Sai Capital, Opp. ICC Senapati Bapat Road  
Pune 411016, India

Phone: +91 (0) 206 640 5624  
Website: [www.bannerengineering.co.in](http://www.bannerengineering.co.in)  
Email: [salesindia@bannerengineering.com](mailto:salesindia@bannerengineering.com)

## Mexico

Address:  
Banner Engineering de Mexico Monterrey Head Office  
Edificio VAO Av. David Alfaro Siqueiros No.103 Col. Valle Oriente C.P.66269  
San Pedro Garza Garcia, Nuevo Leon, Mexico

Phone: +52 81 8363 2714 or 01 800 BANNERE (toll free)  
Website: [www.bannerengineering.com.mx](http://www.bannerengineering.com.mx)  
Email: [mexico@bannerengineering.com](mailto:mexico@bannerengineering.com)

## Brazil

Address:  
Banner do Brasil  
Rua Barão de Teffé nº 1000, sala 54  
Campos Elíseos, Jundiaí - SP, CEP.: 13208-761, Brasil

Phone: +1 763 544 3164  
Website: [www.bannerengineering.com.br](http://www.bannerengineering.com.br)  
Email: [brasil@bannerengineering.com](mailto:brasil@bannerengineering.com)

## China

Address:  
Banner Engineering Shanghai Rep Office  
Xinlian Scientific Research Building Level 12, Building 2  
1535 Hongmei Road, Shanghai 200233, China

Phone: +86 212 422 6888  
Website: [www.bannerengineering.com.cn](http://www.bannerengineering.com.cn)  
Email: [sensors@bannerengineering.com.cn](mailto:sensors@bannerengineering.com.cn)

## Japan

Address:  
Banner Engineering Japan  
Cent-Urban Building 305 3-23-15 Nishi-Nakajima Yodogawa-Ku  
Osaka 532-0011, Japan

Phone: +81 (0)6 6309 0411  
Website: [www.bannerengineering.co.jp](http://www.bannerengineering.co.jp)  
Email: [mail@bannerengineering.co.jp](mailto:mail@bannerengineering.co.jp)

## Taiwan

Address:  
Banner Engineering Taiwan  
8F-2, No. 308 Section 1, Neihu Road  
Taipei 114, Taiwan

Phone: +886 (0)2 8751 9966  
Website: [www.bannerengineering.com.tw](http://www.bannerengineering.com.tw)  
Email: [info@bannerengineering.com.tw](mailto:info@bannerengineering.com.tw)

## 9 Banner Engineering Corp. Limited Warranty

Banner Engineering Corp. warrants its products to be free from defects in material and workmanship for one year following the date of shipment. Banner Engineering Corp. will repair or replace, free of charge, any product of its manufacture which, at the time it is returned to the factory, is found to have been defective during the warranty period. This warranty does not cover damage or liability for misuse, abuse, or the improper application or installation of the Banner product.

THIS LIMITED WARRANTY IS EXCLUSIVE AND IN LIEU OF ALL OTHER WARRANTIES WHETHER EXPRESS OR IMPLIED (INCLUDING, WITHOUT LIMITATION, ANY WARRANTY OF MERCHANTABILITY OR FITNESS FOR A PARTICULAR PURPOSE), AND WHETHER ARISING UNDER COURSE OF PERFORMANCE, COURSE OF DEALING OR TRADE USAGE.

This Warranty is exclusive and limited to repair or, at the discretion of Banner Engineering Corp., replacement. IN NO EVENT SHALL BANNER ENGINEERING CORP. BE LIABLE TO BUYER OR ANY OTHER PERSON OR ENTITY FOR ANY EXTRA COSTS, EXPENSES, LOSSES, LOSS OF PROFITS, OR ANY INCIDENTAL, CONSEQUENTIAL OR SPECIAL DAMAGES RESULTING FROM ANY PRODUCT DEFECT OR FROM THE USE OR INABILITY TO USE THE PRODUCT, WHETHER ARISING IN CONTRACT OR WARRANTY, STATUTE, TORT, STRICT LIABILITY, NEGLIGENCE, OR OTHERWISE.

Banner Engineering Corp. reserves the right to change, modify or improve the design of the product without assuming any obligations or liabilities relating to any product previously manufactured by Banner Engineering Corp. Any misuse, abuse, or improper application or installation of this product or use of the product for personal protection applications when the product is identified as not intended for such purposes will void the product warranty. Any modifications to this product without prior express approval by Banner Engineering Corp will void the product warranties. All specifications published in this document are subject to change; Banner reserves the right to modify product specifications or update documentation at any time. Specifications and product information in English supersede that which is provided in any other language. For the most recent version of any documentation, refer to: [www.bannerengineering.com](http://www.bannerengineering.com).