

# SM-xA-5A Safety Mat Monitoring Modules



## Datasheet

SM-GA-5A (12-24 V dc / 115 V ac operation) and SM-HA-5A (12-24 V dc / 230 V ac operation)



- Monitors one 4-wire safety mat, or multiple mats in series
- Selectable Automatic (Auto) Reset or Monitored Manual Reset
- Input monitoring circuit incorporates redundant microprocessors
- Plug-in terminal blocks
- Four normally open output switching channels for connection to control-reliable power interrupt circuits and one normally closed auxiliary output channel for status monitoring
- Two auxiliary solid-state outputs indicate state of internal relays K1 and K2, and state of system (ON = normal operation)
- 6 amp safety output contacts; 5 amp aux. output contacts
- DIN-rail-mountable 45 mm-wide housing
- External device monitoring (one-channel EDM)
- Design complies with UL 991, ISO 13856-1, ISO 13849-1 (EN 954-1) Category 4: Internal Module, or Category 3 with 4-wire Safety Mat connected



**WARNING: Not a Stand-Alone Safeguarding Device**

This Banner device is considered complementary equipment that is used to augment safeguarding that limits or eliminates an individual's exposure to a hazard without action by the individual or others. Failure to properly safeguard hazards according to a risk assessment, local regulations, and relevant standards may lead to serious injury or death.

## Models

Model	Supply Voltage	Outputs	Output Rating
SM-GA-5A	12 to 24 V dc or 115 V ac	4 Normally Open Safety	N.O. Safety Outputs: 6 A
SM-HA-5A	12 to 24 V dc or 230 V ac	1 Normally Closed Aux. 2 Solid-State Aux.	N. C. Aux. Outputs: 5 A SS Aux Outputs: 100 mA

## Important... Read This Before Proceeding

The user is responsible for satisfying all local, state, and national laws, rules, codes, and regulations relating to the use of this product and its application. Banner Engineering Corp. has made every effort to provide complete application, installation, operation, and maintenance instructions. Please direct any questions regarding the use or installation of this product to the factory applications department at the telephone numbers or address found at <http://www.bannerengineering.com>.

The user is responsible for making sure that all machine operators, maintenance personnel, electricians, and supervisors are thoroughly familiar with and understand all instructions regarding the installation, maintenance, and use of this product, and with the machinery it controls. The user and any personnel involved with the installation and use of this product must be thoroughly familiar with all applicable standards, some of which are listed within the specifications. Banner Engineering Corp. makes no claim regarding a specific recommendation of any organization, the accuracy or effectiveness of any information provided, or the appropriateness of the provided information for a specific application.



## Overview

Safety Mat Monitor Modules SM-GA-5A and SM-HA-5A (the "Safety Module") are used to verify the proper operation of 4-wire presence-sensing switching mats (sensors).

Multiple mats may be switched in series to one Safety Module. The Safety Module provides the redundant safety outputs required for creating a control-reliable safety circuit. The Safety Module has two functions:

- To monitor the conductive elements (plates) and the wiring of one or more safety mat(s) for failures and prevent the machine from restarting if any mat or the Module fails
- To provide a reset routine after the operator steps off the safety mat. This prevents the controlled machinery from restarting automatically after the mat is cleared. This necessary reset/restart function is required by ANSI B11 and ANSI NFPA 79 machine safety standards. If the Module is used in auto-reset mode, the reset/restart function must be provided by the machine control system



**NOTE:** The Safety Module is not designed to monitor 2-wire mats, bumpers, or edges (with or without sensing resistors).

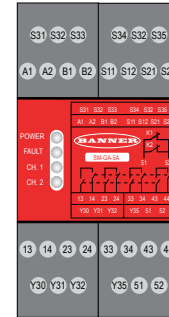

Figure 1. Indicator and Terminal Locations

In operation, the Safety Module monitors the conductive elements (plates) of the pressure-sensitive mat for shorting of those elements (that is, when the mat is stepped on) and certain faults, such as shorts to other sources of power or ground (0 V), or open connecting wires. With a +24 V dc supply, Channel 1 (S11-S12) supplies > 20 V dc that is pulsed low and Channel 2 (S21-S22) supplies < 2 V that is pulsed high; when these two channels are shorted together, the safety output contacts open (13-14, 23-24, 33-34, and 43-44).

If a fault is detected, the Module will lock out, open its safety outputs, and indicate the problem on its LED display, which can be diagnosed by using the troubleshooting table in this document. After repairing the fault, step on the mat and off it again to clear the lockout condition (or cycle power). If the fault has been cleared and no other faults exist, the Fault LED turns OFF and the Module can be reset (if configured for Auto Reset, the safety outputs will turn ON immediately).

The output relays energize automatically if the Module is wired for Auto Reset mode, all sensors are clear, all faults are removed or corrected, and power is applied. The Module requires a manual reset if it is wired for Manual Reset mode.

## Application of Pressure-Sensitive Mats and Floors

Pressure-sensitive mats and pressure-sensitive floors must meet the requirements of the category and performance level for which they are specified and marked. These requirements are defined in ISO 13849-1 (EN 954-1).

The Safety Module is designed to monitor 4-wire safety mats; it is not recommended to use two-wire devices (mats, sensing edges, etc., with two wires and a "sensing" resistor). While the Module internally meets or exceeds ISO 13849-1 (EN 954-1) Category 4 requirements, the overall safety circuit performance is determined by the mat(s) or other sensor(s) connected to the Module.



### WARNING: Application of Safety Mats

Safety Mat application requirements vary for the level of control reliability or category and performance level as described by ISO 13849-1 (EN 954-1) and ISO 13856. While Banner Engineering always recommends the highest level of safety in any application, the user is responsible to safely install, operate, and maintain each safety system per the manufacturer's recommendations and comply with all relevant laws and regulations.

Do not use safety mats as a tripping device to initiate machine motion (such as in a presence-sensing device initiation application), due to the possibility of unexpected start or re-start of the machine cycle resulting from failure(s) within the mat and the interconnect cabling.

Do not use a safety mat to enable or provide the means to allow the machine control to start hazardous motion by simply standing on the safety mat (for example, at a control station). This type of application uses reverse/negative logic and certain failures (for example, loss of power to the Module) can result in a false enable signal.

## Safety Circuit Integrity and ISO 13849-1 Safety Circuit Principles

Safety circuits involve the safety-related functions of a machine that minimize the level of risk of harm. These safety-related functions can prevent initiation, or they can stop or remove a hazard. The failure of a safety-related function or its associated safety circuit usually results in an increased risk of harm.

The integrity of a safety circuit depends on several factors, including fault tolerance, risk reduction, reliable and well-tried components, well-tried safety principles, and other design considerations.

Depending on the level of risk associated with the machine or its operation, an appropriate level of safety circuit integrity (performance) must be incorporated into its design. Standards that detail safety performance levels include ANSI B11.19 Performance Criteria for Safeguarding and ISO 13849-1 Safety-Related Parts of a Control System.

### Safety Circuit Integrity Levels

Safety circuits in International and European standards have been segmented into Categories and Performance Levels, depending on their ability to maintain their integrity in the event of a failure and the statistical likelihood of that failure. ISO 13849-1 details safety circuit integrity by describing circuit architecture/structure (Categories) and the required performance level (PL) of safety functions under foreseeable conditions.

In the United States, the typical level of safety circuit integrity has been called "Control Reliability". Control Reliability typically incorporates redundant control and self-checking circuitry and has been loosely equated to ISO 13849-1 Category 3 or 4 and/or Performance Level "d" or "e" (see ANSI B11.19).

Perform a risk assessment to ensure appropriate application, interfacing/hookup, and risk reduction (see ANSI B11.0 or ISO 12100). The risk assessment must be performed to determine the appropriate safety circuit integrity in order to ensure that the expected risk reduction is achieved. This risk assessment must take into account all local regulations and relevant standards, such as U.S. Control Reliability or European "C" level standards.

### Fault Exclusion

An important concept within the requirements of ISO 13849-1 is the probability of the occurrence of a failure, which can be reduced using a technique termed "fault exclusion." The rationale assumes that the possibility of certain well-defined failure(s) can be reduced via design, installation, or technical improbability to a point where the resulting fault(s) can be, for the most part, disregarded—that is, "excluded" in the evaluation.

Fault exclusion is a tool a designer can use during the development of the safety-related part of the control system and the risk assessment process. Fault exclusion allows the designer to design out the possibility of various failures and justify it through the risk assessment process to meet the requirements of ISO 13849-1/-2.

## Safety Mat Requirements



### WARNING: Risk Assessment

The level of safety circuit integrity can be greatly affected by the design and installation of the safety devices and the means of interfacing of those devices. A risk assessment must be performed to determine the appropriate level of safety circuit integrity to ensure the expected risk reduction is achieved and all relevant regulations and standards are complied with.

The following are minimum requirements for the design, construction, and installation of four-wire safety mat sensor(s) to be interfaced with the SM-xA-5A Module. These requirements are a summary of standards ISO 13856-1 and ANSI/B11.19. Review all relevant applicable regulations and standards and apply the Module and any sensors in full compliance.

### Design and Constructions

The safety mat system [Safety Module, sensor(s), and any additional devices] must have a response time that is fast enough (less than 100 to 200 ms, depending on the relevant standard) to reduce the possibility of an individual stepping lightly and quickly over the mat's sensing surface, without being detected.

For a safety mat system, the minimum object sensitivity of the sensor must detect, at a minimum, a 30 kg (66 lb.) weight on an 80 mm (3.125 in) diameter circular disk test piece, anywhere on the mat's sensing surface, including at joints and junctions. The effective sensing surface or area must be identifiable and can comprise one or more sensors. The safety mat supplier should state this minimum weight and diameter as the minimum object sensitivity of the sensor.

User adjustments to actuating force and response time are not allowed (ISO 13856-1). The sensor should be manufactured to prevent any reasonably foreseeable failures (for example, oxidation of the contact elements) which could cause a loss in sensitivity.

The sensor must meet a minimum environmental rating of IP54. When the sensor is specified for immersion in water, the sensor's minimum environmental rating must be IP67. Special attention may be required to the interconnect cabling; wicking action may result in the ingress of liquid into the mat, possibly causing loss of sensor sensitivity. The termination of the interconnect cabling may need to be located in an enclosure that has an appropriate environmental rating.

The sensor must not be adversely affected by the environmental conditions for which the system is intended. The effects on the sensor of liquids and other substances which can be expected must be taken into account. For example, long-term exposure to some liquids can cause degradation or swelling of the sensor's housing material, resulting in an unsafe condition.

The sensor's top surface should be a lifetime non-slip design, or otherwise minimize the possibility of slipping, under the expected operating conditions.

The four-wire connection between the Module interconnect cables and the sensor must withstand dragging or carrying the sensor by its cable without failing in an unsafe manner (for example, broken connections due to sharp pulls, steady pulls, or continuous flexing). If not, an alternate means must be employed to avoid such a failure, for example, a cable which disconnects without damage and results in a safe situation.

## Installation

The mounting surface quality and preparation for the sensor must meet the requirements stated by the sensor's manufacturer. Irregularities in the floor (or other mounting surfaces) may impair the function of the sensor and therefore should be reduced to an acceptable minimum.

The mounting surface should be level and clean. Avoid the collection of fluids under or around the sensor. Prevent the risk of failure due to build-up of dirt, turning-chips, or other material under the sensor(s) or the associated hardware. Give special consideration to joints between sensors to ensure that foreign material does not migrate under or into the sensor.

Immediately repair or replace any damage (for example, cuts, tears, wear, or punctures) to the outer insulating jacket of the interconnect cable (in the presence of fluids) or to any part of the exterior of the sensor. Ingress of material (including dirt particles, insects, fluid, moisture, or turning-chips) which may be present near the mat can cause the sensor to corrode or to lose its sensitivity.

Routinely inspect and test the sensor(s) per the manufacturer's recommendations. Care must be taken not to exceed operational specifications (for example, the maximum number of switching operations).

Securely mount the sensor(s) to prevent inadvertent movement (creeping) or unauthorized removal. Methods include (but are not limited to) secured edging or trim, tamper-resistant or one-way fasteners, and recessed flooring or mounting surface, in addition to the size and weight of large mats.

Install the sensor(s) to minimize tripping hazards (particularly towards the hazard). A tripping hazard may exist when the difference in height of an adjacent horizontal surface is 4 mm (1/8 in) or more. Minimize tripping hazards at joints, junctions, edges, and when additional coverings are used. Methods include a ground-flush installation of the sensor, or a ramp that does not exceed 20° from horizontal. Use contrasting colors or markings to identify ramps and edges.

Size and position the safety mat system so that persons cannot enter the hazardous area without being detected, and can not reach the hazard before the hazardous conditions have ceased. Additional guards or safeguarding devices may be required to ensure that exposure to the hazard(s) is not possible by reaching over, under or around the device's sensing surface.

Take into account the possibility of easily stepping over the sensing surface without being detected. ANSI and international standards require a minimum depth of field of the sensor surface (the smallest distance between the edge of the mat and hazard) to be between 750 mm to 1200 mm (30 in to 48 in), depending on the application and the relevant standard. Prevent the possibility of stepping on machine supports or other physical objects to bypass or climb over the sensor.

## Separation Distance

As a stand-alone safeguard, the sensor must be installed at a separation distance (safety distance) such that the exterior edge of the sensing surface is at or beyond the safety distance, unless solely used to prevent start/restart or solely used for clearance safeguarding (see ANSI B11.19).

The separation distance required for an application depends upon several factors, including the speed of the hand (or individual), the total system stopping time (which includes several response time components), and the depth penetration factor. The user must refer to the relevant standard to determine the appropriate distance or means to ensure that individuals can not be exposed to the hazard(s).

One formula used to calculate separation distance ( $D_s$ ) is:

$$D_s = K \times (T_s + T_r) + D_{pf}$$

where:

$K$  = the OSHA-recommended hand speed constant of 1600 mm (63 in) per second (see NOTE below);

$T_s$  = the overall stop time of the machine, measured from the application of the "stop" signal to the final ceasing of all motion (including stop times of all relevant control elements, and measured at maximum machine velocity).

$T_r$  = the response time of the safety mat system: Module response time plus the response time of the sensor(s), as stated by the manufacturer.

$D_{pf}$  = the added distance due to depth penetration factor: 1.2 m (48 in)

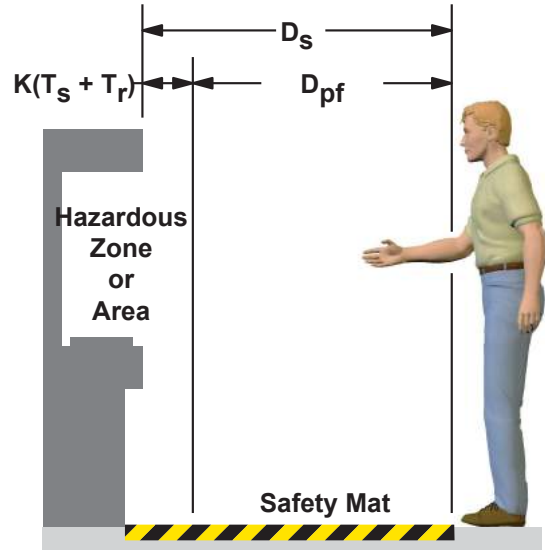

Figure 2. Determining Separation Distance for the Safety Mat



NOTE: The OSHA-recommended hand-speed constant ( $K$ ) has been determined by various studies, and although these studies indicate speeds of 1600 mm (63 in) per second to more than 2540 mm (100 in) per second, they are not conclusive determinations. The employer should consider all factors, including the physical ability of the operator, when determining the value of  $K$  to be used.

If an individual can cross completely over the sensor and be no longer detected, supplemental safeguarding or other means should be used to prevent unexpected startup and exposure to a hazard. At a minimum, the safety mat system (or the machine control) must be manually reset and require re-initiation of the normal actuating means prior to the start or re-start of the machine cycle.

## Mechanical Installation

The Safety Module must be installed inside an enclosure.

It is not designed for exposed wiring. It is the user's responsibility to house the Safety Module in an enclosure with NEMA 3 (IEC IP54) rating, or better. The Safety Module mounts directly to standard 35 mm DIN rail.

**Heat Dissipation Considerations:** For reliable operation, ensure that the operating specifications are not exceeded. The enclosure must provide adequate heat dissipation, so that the air closely surrounding the Module does not exceed the maximum operating temperature stated in the Specifications. Methods to reduce heat build-up include venting, forced airflow (for example, exhaust fans), adequate enclosure exterior surface area, and spacing between modules and other sources of heat.

## Electrical Installation



### WARNING: Shock Hazard and Hazardous Energy

Always disconnect power from the safety system (for example, device, module, interfacing, etc.) and the machine being controlled before making any connections or replacing any component.

Electrical installation and wiring must be made by Qualified Personnel<sup>1</sup> and must comply with the relevant electrical standards and wiring codes, such as the NEC (National Electrical Code), ANSI NFPA79, or IEC 60204-1, and all applicable local standards and codes.

Lockout/tagout procedures may be required. Refer to OSHA 29CFR1910.147, ANSI Z244-1, ISO 14118, or the appropriate standard for controlling hazardous energy.

Electrical installation must be made by qualified personnel<sup>2</sup> and must comply with NEC (National Electrical Code), ANSI/NFPA 79 or IEC/EN 60204-1, and all applicable local standards. It is not possible to give exact wiring instructions for a device that interfaces to a multitude of machine control configurations. The following guidelines are general in nature. Perform a risk assessment to ensure appropriate application, interfacing/hookup, and risk reduction (see ANSI B11.0 or ISO 12100).

The Safety Module is powered by either a 12-24 V dc supply at 4 W or an ac supply (115 V ac, model SM-GA-5A, or 230 V ac, model SM-HA-5A) at 7 VA. The sensor circuit, which monitors the conductive elements (plates) of the safety mat, consists of two channels (A and B) that issue a stop command (that is, open the safety outputs) when an individual steps onto the safety mat, shorting the two channels together.

It is not possible to give exact wiring instructions for a Safety Module that interfaces to a multitude of machine control configurations. The following guidelines are general in nature.

Since the Safety Module functions by detecting the short circuit between the channels, resistance to electrical current flow in the contact monitoring circuit impacts the operation and the safety of the system. Total resistance includes contact resistance of the internal mat contacts, the number of mats in the circuit, and the wire resistance of the interconnect cables and connections.

The only limitation on the number of mats that can be connected in series is the amount of resistance. The total resistance within each channel can not exceed 250 ohms when the Module is supplied by 24 V dc or an ac power supply, and no more than 25 ohms when the Module is supplied by 12 V dc.

The resistance between the channels when shorted together (that is, when an individual steps on the mat) can not exceed 150 ohms (24 V dc or an ac supply) or 10 ohms (12 V dc supply).



### WARNING: Multiple Safety Mats

Whenever two or more safety mats are connected to the same Safety Mat Monitor Module, the corresponding conductive elements (plates) of all mats must be connected together in series, as shown in the hookup drawing. Never connect the conductive elements (plates) of multiple safety mats in parallel; this defeats the ability of the Safety Module to detect open connection wires to each mat, which would create an unsafe condition that may result in serious injury or death.



NOTE: NOTE: The minimum amount of time for the Module to detect a STOP condition is 15 milliseconds. This "recovery time" (OFF state) is required for the internal integrity tests to complete, allowing a reliable reset to occur. A lockout may occur if the Module is cycled too quickly. To clear the lockout, the inputs must be re-cycled, meeting the minimum recovery time requirements.

## Safety Mat Device Checkout - Prior to Module Connection

Before connecting the safety mat to the Module, verify the installation does not exceed the maximum resistance specification. Check the mat with an ohmmeter to verify that none of the following values are exceeded.

<sup>1</sup> A person who, by possession of a recognized degree or certificate of professional training, or who, by extensive knowledge, training and experience, has successfully demonstrated the ability to solve problems relating to the subject matter and work.

<sup>2</sup> A person who, by possession of a recognized degree or certificate of professional training, or who, by extensive knowledge, training, and experience has successfully demonstrated the ability to solve problems relating to the subject matter and work.

1. Check the leadwire resistance.

- a) Keeping track of which wire goes to which terminal, disconnect all 4 wires from the terminal blocks.
- b) Measure and record the resistance between the wires going to terminals S11 and S12: \_\_\_\_\_ (=Ra)
- c) Measure and record the resistance between the wires going to terminals S21 and S22: \_\_\_\_\_ (=Rb)
- d) Review the values for Ra and Rb.

If both Ra and Rb are

Less than 50 ohms Then The lead resistance is acceptable for all supply voltages; check the mat resistance next. If it is 50 ohms or more for either, continue below.

Less than 500 ohms Then The lead resistance is acceptable for an AC supply and for a DC supply >20 V. If resistance is acceptable for your supply, check the mat resistance next. If resistance is not acceptable, lower the lead resistance by shortening the leadwires or by increasing the wire diameter. Recheck Ra and Rb.

2. Check the mat resistance.

- a) Step on the mat in various locations while taking the measurements listed below.
- b) Measure and record the highest observed resistance between S11 and S21: \_\_\_\_\_ (=Rc)
- c) Measure and record the highest observed resistance between S21 and S22: \_\_\_\_\_ (=Rd)
- d) Review the values for Rc and Rd.

If both Rc and Rd are

Then

Less than 10 ohms

The mat and leadwire resistance is acceptable for all supply voltages and the safety mat checkout is complete.

Less than 150 ohms AND you are using an AC supply or DC supply greater than 20 V dc

The mat and leadwire resistance is acceptable and the safety mat checkout is complete.

Any other value

If resistance is not acceptable, proceed to the next step.

3. Connect the ohmmeter to the wires to be connected to S11-S12 (Channel A), and note the resistance.

4. Connect the ohmmeter to the wires to be connected to S21-S22 (Channel B), and note the resistance.

5. Perform the following calculation:  $R_m = (R_c + R_d - R_a - R_b)/2$ .

If Rm is:

Then

Less than 10 ohms

The mat resistance is acceptable for all supply voltages; the safety mat checkout is complete.

Less than 150 ohms AND you are using an AC supply or DC supply greater than 20 V dc

The mat resistance is acceptable and the safety mat checkout is complete.

Any other value

The resistance in the mat is too high for safe operation. Replace the safety mat. Repeat the mat resistance checkout for the new mat.



**WARNING: Safety Mat Resistance Values**

Exceeding the maximum resistance *between the monitoring channels* (usually due to degradation of the mat) can result in the increase of response time or complete loss of the sensing function of the safety mat, when it is stepped on (shorted). This can result in serious injury or death.

Exceeding the maximum resistance *within a contact monitoring channel* can result in the Module issuing a stop command (opening the safety outputs) when no person is present.

To ensure proper operation, verify the quality and specifications of the mat being connected to this Module, and perform periodic checks of the safety mat's resistance, as described in the Safety Mat Initial Checkout.

### Connection of Reset Switch

The reset circuit switch can be any mechanical switch, such as a normally open momentary switch, or a two-position key switch. The reset switch must be capable of reliably switching 12 to 30 V dc at 20 to 50 milliamps. As shown in the hookup drawings, the reset switch connects between Safety Module terminals S33 and S34.

The reset switch must be located outside of – and not be accessible from – the area of dangerous motion, and must be positioned so that any area of dangerous motion may be observed by the switch operator during the reset procedure. See warning below.



**WARNING: Reset Switch Location**

All reset switches must be accessible only from outside, and in full view of, the hazardous area. Reset switches must also be out of reach from within the safeguarded space, and must be protected against unauthorized or inadvertent operation (for example, through the use of rings or guards). If any areas are not visible from the reset switch(es), additional means of safeguarding must be provided. Failure to do so may result in serious bodily injury or death.

## Automatic Reset Mode

The Safety Module may be configured (via hookup) for automatic reset. If no MSC contacts are monitored, install a jumper between terminals S32 and S35 (see hookups). The Safety Module will reset (and its outputs energize) as soon as the switch returns to its armed (closed-contact) position.

Automatic reset is useful for some automated processes. However, if automatic reset is used, it is necessary to provide a means of preventing resumption of hazardous machine motion, until an alternate reset procedure is performed. The alternate procedure must include a reset/restart switch, located outside the area of dangerous motion and positioned so that any area of dangerous motion may be observed by the switch operator during the reset procedure. See Warning.

**WARNING: Reset Routine Required**

U.S. and international standards require that a reset routine be performed after clearing the cause of a stop condition (for example, arming an E-stop button, closing an interlocked guard, etc.). Allowing the machine to restart without actuating the normal start command/device can create an unsafe condition which may result in serious injury or death.

## Connection to the Machine to be Controlled

The machine hookup diagram shows a generic connection of the Safety Module's redundant output circuits to the master stop control elements (MSCs). An MSC is defined as an electrically powered device, external to the Safety Module, which stops the machinery being controlled by immediately removing electrical power to the machine and (when necessary) by applying braking to dangerous motion. This stopping action is accomplished by removing power to the actuator of either MSC.

## External Device Monitoring

To satisfy the requirements of Control Reliability (OSHA and ANSI), Category 3 and 4 of ISO 13849-1 (EN 954-1), the Master Stop Control Elements (MSCs) must each offer a normally closed, forced-guided (mechanically linked) monitor contact. Connect one normally closed monitor contact from each master stop control element in series to S31 and S32.

In operation, if one of the switching contacts of either MSC fails in the energized condition, the associated monitor contact will remain open. Therefore, it will not be possible to reset the Safety Module. If no MSC-monitor contacts are monitored, a jumper must be installed between terminals S31-S32, as shown in the hookup drawings. It is the user's responsibility to ensure that any single failure will not result in a hazardous condition and will prevent a successive machine cycle.



Series Connection of Multiple Safety Mats  
 The number of mats is limited by the total series resistance per input channel. See section, "Safety Mat Device Checkout" and warning, "Safety Mat Resistance Values."

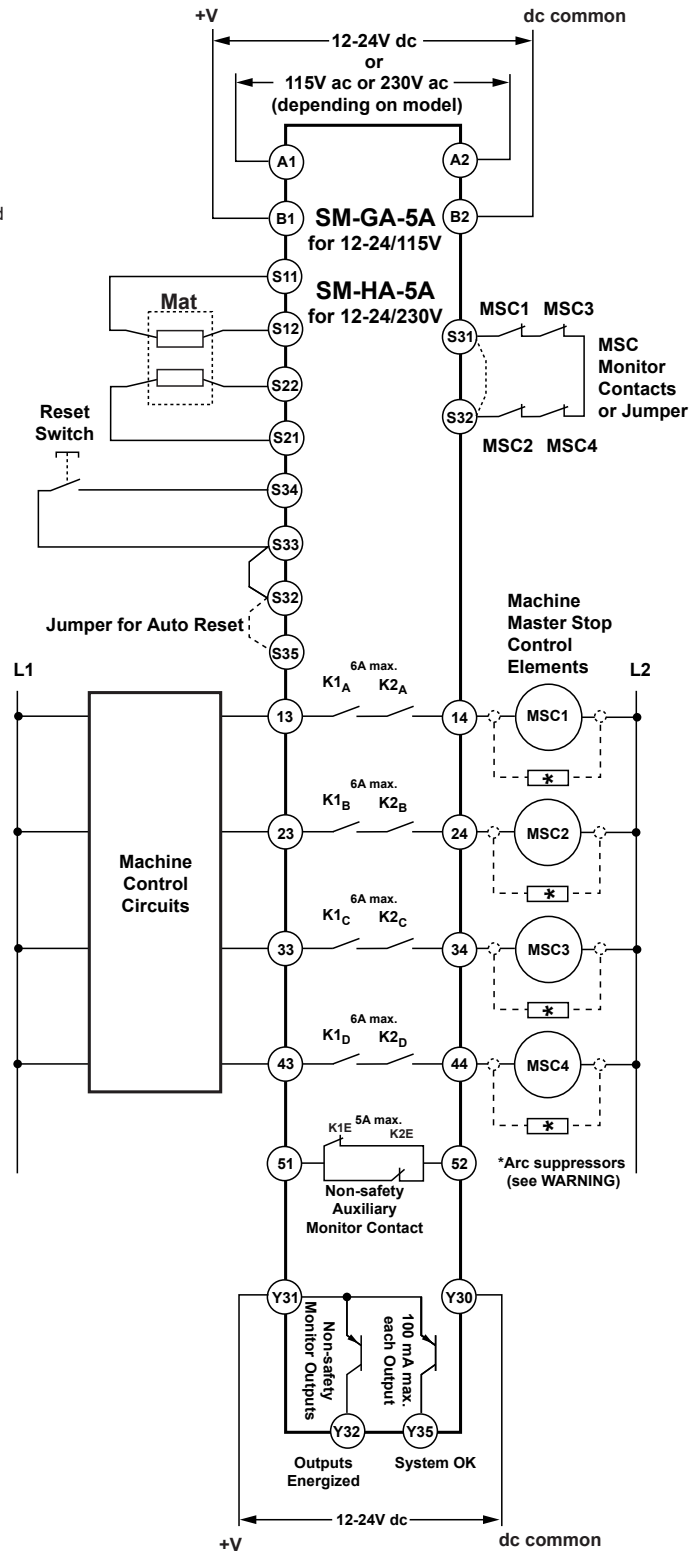
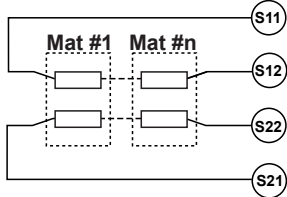

Figure 3. Hookup to a Four-Wire Safety Mat

**WARNING: Wiring of Arc Suppressors**

If arc suppressors are used, they **MUST** be installed as shown across the actuator coil of the stop control elements (MSCs or MPCEs). **NEVER** install suppressors directly across the output contacts of the Safety Device or Module. It is possible for suppressors to fail as a short circuit. If installed directly across the output contacts, a short-circuited suppressor creates an unsafe condition which may result in serious injury or death.

**WARNING: Interfacing MSCs**

Do not wire an intermediate device(s) (for example, PLC, PES, PC) between the Safety Module outputs and the Master Stop Control Element it switches in such a manner that in the event of a failure there is a loss of the safety stop command, or in such a manner that the safety function can be suspended, overridden, or defeated, unless accomplished with the same or greater degree of safety.

Whenever forced-guided, mechanically linked relays are added as intermediate switching devices, a normally closed (N.C.) forced-guided monitor contact from each relay must be added to the series feedback loop between Safety Module terminals S31 and S32.

## Overvoltage Category II and III Installations (EN50178 and IEC60664-1)

The Safety Module is rated for Overvoltage Category III when voltages of 1 V to 150 V ac/dc are applied to the output relay contacts. It is rated for Overvoltage Category II when voltages of 151 V to 250 V ac/dc are applied to the output relay contacts and no additional precautions are taken to attenuate possible overvoltage situations in the supply voltage. The Module can be used in an Overvoltage Category III environment (with voltages of 151 V to 250 V ac/dc) if care is taken either to reduce the level of electrical disturbances seen by the Module to Overvoltage Category II levels by installing surge suppressor devices (for example, arc suppressors), or to install extra external insulation in order to isolate both the Safety Module and the user from the higher voltage levels of a Category III environment.

For Overvoltage Category III installations with applied voltages from 151 V to 250 V ac/dc applied to the output contact(s): the Safety Module may be used under the conditions of a higher overvoltage category where appropriate overvoltage reduction is provided. Appropriate methods include:

- An overvoltage protective device
- A transformer with isolated windings
- A distribution system with multiple branch circuits (capable of diverting energy of surges)
- A capacitance capable of absorbing energy of surges
- A resistance or similar damping device capable of dissipating the energy of surges

When switching inductive ac loads, it is good practice to protect the Safety Module outputs by installing appropriately-sized arc suppressors. However, if arc suppressors are used, they must be installed across the load being switched (for example, across the coils of external safety relays), and never across the Safety Module's output contacts (see WARNING, Arc Suppressors).

## Auxiliary Monitor Contact/Solid-State Monitor Outputs Connection

The action of the auxiliary monitor contact, terminals 51-52, inversely "follows" the action of the safety outputs. Two additional solid-state monitor outputs (at terminals Y32 and Y35) each are capable of switching up to 100 mA at 12- 24 V dc. The output at terminal Y32 follows the action of the output circuits (K1 and K2); the output at terminal Y35 opens (low signal) when there is a loss of power or a fault is detected. These outputs are to be used only for nonsafety functions (typically, to communicate the status of the Safety Module to a programmable logic controller). See the appropriate figure for wiring information.

## Safety Mat Module Initial Checkout Procedure

**WARNING:**

Checkouts for Multiple Safety Devices. If more than one safety mat is series-connected to one Safety Mat Monitor Module, run this checkout procedure individually for each mat.



**CAUTION: Disconnect Power Prior to Checkout**

Before performing the initial checkout procedure, make certain all power is disconnected from the machine to be controlled.

Dangerous voltages may be present along the Safety Module wiring barriers whenever power to the machine control elements is On. Exercise extreme caution whenever machine control power is or may be present. Always disconnect power to the machine control elements before opening the enclosure housing of the Safety Module.

1. Remove power to the machine control elements, if it is already connected.
2. Apply force to the mat's sensing area, using a test piece as outlined in the mat manufacturer's literature, or the appropriate standard.
3. Apply input power to the Safety Mat Monitor Module at terminals A1 and A2 or B1 and B2. Verify that only the Power indicator LED is ON.
4. Remove the test piece from the safety mat (clear the mat sensing area).
5. Manual Reset mode: Ch1 and Ch2 indicators should be flashing. Close and reopen the Reset switch.
6. Verify that the Ch1 and Ch2 indicators both come ON. If only one indicator comes ON or if any indicator is flashing, refer to the Troubleshooting section for more information. Return to step 2 after correcting the problem.
7. Apply force in several locations (using a test piece) to the mat's sensing area, per the mat manufacturer's recommendations. Verify that the Ch1 and Ch2 indicators turn OFF simultaneously. If either indicator does not go OFF, disconnect the input power and check all wiring. Return to step 2 after correcting the problem.
8. Repeat for each safety mat individually.
9. Close and secure the enclosure. Apply power to the machine control elements and perform the following Periodic Checkout Procedure.

## Safety Mat System Periodic Checkout Procedure

Verify the functioning of the safety mat monitoring system periodically to ensure proper operation (see also the machine manufacturer's recommendations).



**WARNING:**

Checkouts for Multiple Safety Devices. If more than one safety mat is series-connected to one Safety Mat Monitor Module, run this checkout procedure individually for each mat.

1. With the machine running, apply force to the mat's sensing area, using a test piece as described in the mat manufacturer's literature, or the appropriate standard. Verify that the machine stops within the expected time period.
2. Remove the test piece from the safety mat. Verify that the machine does not restart.
3. Close and then open the Reset switch (if using Manual Reset mode). Verify that the machine cycle can be restarted by normal initiation.
4. Repeat for each safety mat individually.

## Troubleshooting

Use the LED display to help diagnose the problem. After fixing the fault:

- Manual Reset configured — step ON and OFF the mat to clear the lockout.
- Auto Reset configured — the outputs turn ON immediately.

The Fault LED turns OFF if the proper repair has been made.

Condition	Indicator Status	Possible Causes or Solution
Module will not reset	Power LED ON	Waiting for manual reset: <ul style="list-style-type: none"> <li>• EDM monitoring contacts are not closed. Check MSCs.</li> <li>• Check jumper at S32-S35 (auto reset) or S32-S33 (manual reset).</li> <li>• Check reset button connection.</li> </ul>
	Fault LED OFF	
	Ch1 LED Flashing	
	Ch2 LED Flashing	
No fault indicated	Power LED ON	Safety mat appears actuated: <ul style="list-style-type: none"> <li>• Check mat for damage or heavy debris.</li> <li>• Check for proper wiring.</li> <li>• Check for a short in the wiring.</li> </ul>
	Fault LED OFF	
	Ch1 LED OFF	

Condition	Indicator Status	Possible Causes or Solution
No fault indicated	Ch2 LED OFF	Channel 1 open: <ul style="list-style-type: none"> <li>• Check wiring to S11-S12.</li> <li>• Check connectors are properly seated.</li> </ul>
	Power LED ON	
	Fault LED ON*	
	Ch1 LED OFF	
No fault indicated	Ch2 LED ON	Channel 2 open: <ul style="list-style-type: none"> <li>• Check wiring to S21-S22.</li> <li>• Check connectors are properly seated.</li> </ul>
	Power LED ON	
	Fault LED ON*	
	Ch1 LED ON	
Fault	Ch2 LED OFF	Possible temporary fault: <ul style="list-style-type: none"> <li>• Check for loose wiring.</li> <li>• Actuate the mat to clear the fault.</li> </ul>
	Power LED ON	
	Fault LED ON*	Possible internal fault: <ul style="list-style-type: none"> <li>• Return to factory for repair or replacement.</li> </ul>
	Ch1 LED ON	
	Ch2 LED ON	Possible fault in the machine control or wiring to the Module: <ul style="list-style-type: none"> <li>• Check input power connections or external fuses.</li> <li>• Check connectors are properly seated.</li> </ul>
	All LEDs OFF	
	Dim LEDs	
*Fault LED Flickers	This is normal while the Fault LED is ON.	
MSCs do not energize	Power LED ON	Possible fault in machine control or an open circuit between machine control and MSCs: <ul style="list-style-type: none"> <li>• Check continuity of safety outputs (for example, between terminals 13 and 14).</li> <li>• Check control wires and connectors.</li> <li>• Check MSCs</li> </ul>
	Fault LED OFF	
	Ch1 LED ON	
	Ch2 LED ON	

## Repairs

Contact Banner Engineering for troubleshooting of this device. Do not attempt any repairs to this Banner device; it contains no field-replaceable parts or components. If the device, device part, or device component is determined to be defective by a Banner Applications Engineer, they will advise you of Banner's RMA (Return Merchandise Authorization) procedure.



**Important:** If instructed to return the device, pack it with care. Damage that occurs in return shipping is not covered by warranty.















### CAUTION: Abuse of Module After Failure

If an internal fault has occurred and the Module will not reset, do not tap, strike, or otherwise attempt to correct the fault by a physical impact to the housing. An internal relay may have failed in such a manner that its replacement is required.

If the Module is not immediately replaced or repaired, multiple simultaneous failures may accumulate such that the safety function can not be guaranteed.

## Specifications

Category	Specification																																			
Supply Voltage and Current	<p>AI-A2: 115 V ac (model SM-GA-5A) or 230 V ac (model SM-HA-5A) ±15%, 50/60 Hz</p> <p>BI-B2: 11 V dc to 27.6 V dc</p> <p>Connect the Safety Module only to a SELV (safety extra-low voltage, for circuits without earth ground) or a PELV (protected extra-low voltage, for circuits with earth ground) power supply, according to EN IEC 60950, NEC Class 2.</p>																																			
Power Consumption	Approx. 4 W / 7 VA																																			
Supply Protection Circuitry	Protected against transient voltages and reverse polarity																																			
Overvoltage Category	<p>Output relay contact voltage of 1 V to 150 V ac/dc: category III</p> <p>Output relay contact voltage of 151 V to 250 V ac/dc: category III, if appropriate overvoltage reduction is provided, as described earlier.</p>																																			
Pollution Degree	2																																			
Relay Outputs	<p>4 normally open (N.O.) output channels and 1 normally closed (N.C.) output</p> <p>Each normally open output channel is a series connection of contacts from two forced-guided (mechanically linked) relays, K1-K2. The normally closed Aux. output channel is a parallel connection of contacts from two forced-guided relays, K1-K2.</p> <p>Contacts: AgNi, 5 µm gold-plated</p> <p>Low Current Rating: The 5 µm gold-plated contacts allow the switching of low current/low voltage. In these low-power applications, multiple contacts can also be switched in series (for example, "dry switching"). To preserve the gold plating on the contacts, do not exceed the following max. values at any time:</p> <table border="1"> <tr> <td>Min. voltage: 1 V ac/dc</td> <td>Max. voltage: 60 V</td> </tr> <tr> <td>Min. current: 5 mA ac/dc</td> <td>Max. current: 300 mA</td> </tr> <tr> <td>Min. power: 5 mW (5 mVA)</td> <td>Max. power: 7 W (7 VA)</td> </tr> </table> <p>High Current Rating: If higher loads must be switched through one or more of the contacts, the minimum and maximum values of the contact(s) changes to:</p> <table border="1"> <thead> <tr> <th></th> <th>Minimum</th> <th>Maximum</th> </tr> </thead> <tbody> <tr> <td rowspan="3">  </td> <td>Voltage: 15 V ac/dc</td> <td>N.O. Safety Contacts (13-14, 23-24, 33-34, 43-44): 250 V ac / 24 V dc, 6 A resistive B300, Q300 (UL508)</td> </tr> <tr> <td>Current: 250 mA ac/dc</td> <td>N.C. Auxiliary Contact (51-52): 250 V ac / 24 V dc, 5A resistive B300, Q300 (UL508)</td> </tr> <tr> <td>Power: 5 W (5 VA)</td> <td></td> </tr> <tr> <td rowspan="4">  </td> <td>Minimum</td> <td>Maximum — IEC60947-5-1</td> </tr> <tr> <td>Voltage: 15 V ac/dc</td> <td>N.O. Safety Contacts: AC-1: 250 V ac, 6 A; DC-1: 24 V dc, 6 A AC-15: 230 V ac, 3 A; DC-13: 24 V dc, 4 A</td> </tr> <tr> <td>Current: 250 mA ac/dc</td> <td>N.C. Auxiliary Contact: AC-1: 250 V ac, 5 A; DC-1: 24 V dc, 5 A AC-15: 230 V ac, 2 A; DC-13: 24 V dc, 4 A</td> </tr> <tr> <td>Power: 5 W (5 VA)</td> <td></td> </tr> <tr> <td rowspan="3">  </td> <td>Minimum</td> <td>Maximum — IEC60947-5-1</td> </tr> <tr> <td>Voltage: 15 V ac/dc</td> <td>N.O. Safety Contacts: AC-1: 250 V ac, 6 A; DC-1: 24 V dc, 6 A AC-15: 230 V ac, 3 A; DC-13: 24 V dc, 4 A</td> </tr> <tr> <td>Current: 250 mA ac/dc</td> <td>N.C. Auxiliary Contact: AC-1: 250 V ac, 5 A; DC-1: 24 V dc, 5 A AC-15: 230 V ac, 2 A; DC-13: 24 V dc, 4 A</td> </tr> <tr> <td></td> <td>Power: 5 W (5 VA)</td> <td></td> </tr> </tbody> </table> <p>Mechanical life: &gt; 50,000,000 operations</p> <p>Electrical life: 150,000 cycles @ 1500 VA; 1,000,000 cycles @ 450 VA; 2,000,000 cycles @ 250 VA; 5,000,000 cycles @ 125 VA</p> <div style="border: 1px solid black; padding: 5px; margin-top: 10px;">  <p><b>NOTE:</b> NOTE: Transient suppression is recommended when switching inductive loads. Install suppressors across load. Never install suppressors across output contacts (see Warning, Wiring of Arc Suppressors).</p> </div>	Min. voltage: 1 V ac/dc	Max. voltage: 60 V	Min. current: 5 mA ac/dc	Max. current: 300 mA	Min. power: 5 mW (5 mVA)	Max. power: 7 W (7 VA)		Minimum	Maximum		Voltage: 15 V ac/dc	N.O. Safety Contacts (13-14, 23-24, 33-34, 43-44): 250 V ac / 24 V dc, 6 A resistive B300, Q300 (UL508)	Current: 250 mA ac/dc	N.C. Auxiliary Contact (51-52): 250 V ac / 24 V dc, 5A resistive B300, Q300 (UL508)	Power: 5 W (5 VA)			Minimum	Maximum — IEC60947-5-1	Voltage: 15 V ac/dc	N.O. Safety Contacts: AC-1: 250 V ac, 6 A; DC-1: 24 V dc, 6 A AC-15: 230 V ac, 3 A; DC-13: 24 V dc, 4 A	Current: 250 mA ac/dc	N.C. Auxiliary Contact: AC-1: 250 V ac, 5 A; DC-1: 24 V dc, 5 A AC-15: 230 V ac, 2 A; DC-13: 24 V dc, 4 A	Power: 5 W (5 VA)			Minimum	Maximum — IEC60947-5-1	Voltage: 15 V ac/dc	N.O. Safety Contacts: AC-1: 250 V ac, 6 A; DC-1: 24 V dc, 6 A AC-15: 230 V ac, 3 A; DC-13: 24 V dc, 4 A	Current: 250 mA ac/dc	N.C. Auxiliary Contact: AC-1: 250 V ac, 5 A; DC-1: 24 V dc, 5 A AC-15: 230 V ac, 2 A; DC-13: 24 V dc, 4 A		Power: 5 W (5 VA)	
Min. voltage: 1 V ac/dc	Max. voltage: 60 V																																			
Min. current: 5 mA ac/dc	Max. current: 300 mA																																			
Min. power: 5 mW (5 mVA)	Max. power: 7 W (7 VA)																																			
	Minimum	Maximum																																		
	Voltage: 15 V ac/dc	N.O. Safety Contacts (13-14, 23-24, 33-34, 43-44): 250 V ac / 24 V dc, 6 A resistive B300, Q300 (UL508)																																		
	Current: 250 mA ac/dc	N.C. Auxiliary Contact (51-52): 250 V ac / 24 V dc, 5A resistive B300, Q300 (UL508)																																		
	Power: 5 W (5 VA)																																			
	Minimum	Maximum — IEC60947-5-1																																		
	Voltage: 15 V ac/dc	N.O. Safety Contacts: AC-1: 250 V ac, 6 A; DC-1: 24 V dc, 6 A AC-15: 230 V ac, 3 A; DC-13: 24 V dc, 4 A																																		
	Current: 250 mA ac/dc	N.C. Auxiliary Contact: AC-1: 250 V ac, 5 A; DC-1: 24 V dc, 5 A AC-15: 230 V ac, 2 A; DC-13: 24 V dc, 4 A																																		
	Power: 5 W (5 VA)																																			
	Minimum	Maximum — IEC60947-5-1																																		
	Voltage: 15 V ac/dc	N.O. Safety Contacts: AC-1: 250 V ac, 6 A; DC-1: 24 V dc, 6 A AC-15: 230 V ac, 3 A; DC-13: 24 V dc, 4 A																																		
	Current: 250 mA ac/dc	N.C. Auxiliary Contact: AC-1: 250 V ac, 5 A; DC-1: 24 V dc, 5 A AC-15: 230 V ac, 2 A; DC-13: 24 V dc, 4 A																																		
	Power: 5 W (5 VA)																																			

Category	Specification
Solid-State Outputs	<p>Two non-safety solid-state dc outputs</p> <p>Output circuits require application of +12 to 24 V dc <math>\pm</math> 15% at terminal Y31; dc common at Y30.</p> <p>Max. switching current: 100 mA at 12 to 24 V dc</p> <p>Both outputs are protected against short circuits.</p> <p>Output at Y32 monitors state of outputs – conducts (output high) when both K1 and K2 are energized.</p> <p>Output at Y35 conducts (output high) when in normal operation (no lockout).</p>
Output Response Time	35 ms max. (25 ms typical)
Input Requirements	<p>Safety mat normally open contact must be capable of switching 20 to 100 mA at 12 to 30 V dc; and must be closed &gt; 25 ms for a valid stop command.</p> <p>V ac or 24 V dc Supply: Max. lead resistance 250 ohms; max. contact resistance: 150 ohms.</p> <p>12 V dc Supply: Max. lead resistance 25 ohms; max. contact resistance: 10 ohms.</p> <p>Reset switch: must have one normally open contact capable of switching 20 to 50 mA at 12 to 30 V dc.</p>
OFF-State Recovery Time	350 ms maximum
Indicators	<p>3 green LED indicators: Power ON, Channel 1 (high side), Channel 2 (low side)</p> <p>1 red LED indicator: indicates a fault condition (see Troubleshooting)</p>
Construction	Polycarbonate housing. Rated NEMA 1, IEC IP20
Mounting	Mounts to standard 35 mm DIN rail track. Safety Module must be installed inside an enclosure rated NEMA 3 (IEC IP54), or better.
Vibration Resistance	<p>10 to 60 Hz at 0.35 mm peak displacement per UL 991</p> <p>60 to 150 Hz at 5 g max.</p>
Operating Conditions	<p>Temperature: 0 °C to +50 °C (+32 °F to +122 °F), (surrounding air)</p> <p>90% at +50 °C maximum relative humidity (non-condensing)</p>
Design Standards	Cat. 4 PL e per EN ISO 13849-1; SIL 3 per IEC 61508 and IEC 62061
Certifications	  

## Dimensions

All measurements are listed in millimeters (inches), unless noted otherwise.

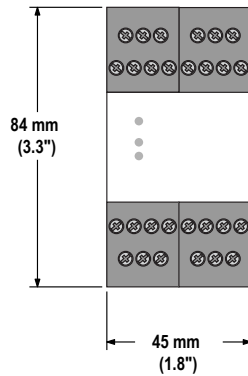
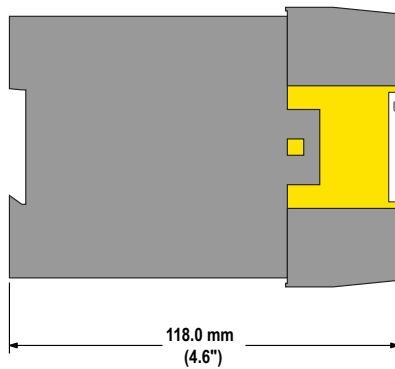

## Certifications and Standards

### EC Declaration of Conformity (DoC)

Banner Engineering Corp. herewith declares that the SM-GA-5A and SM-HA-5A Safety Mat Monitoring Modules are in conformity with the provisions of the Machinery Directive 2006/42/EC and all essential health and safety requirements have been met.

Representative in EU: Peter Mertens, Managing Director Banner Engineering Europe. Address: Park Lane, Culliganlaan 2F, 1831 Diegem, Belgium.

### Standards and Regulations

The list of standards below is included as a convenience for users of this Banner device. Inclusion of the standards below does not imply that the device complies specifically with any standard, other than those specified in the Specifications section of this manual.

#### U.S. Application Standards

ANSI B11.0 Safety of Machinery, General Requirements, and Risk Assessment

ANSI B11.19 Performance Criteria for Safeguarding

ANSI NFPA 79 Electrical Standard for Industrial Machinery

#### International/European Standards

ISO 12100 Safety of Machinery – General Principles for Design — Risk Assessment and Risk Reduction

IEC 60204-1 Electrical Equipment of Machines Part 1: General Requirements

ISO 13856-1 (EN1760-1), Safety of Machinery – Pressure-Sensitive Protective Devices

ISO 13855 (EN 999) The Positioning of Protective Equipment in Respect to Approach Speeds of Parts of the Human Body

IEC 61508 Functional Safety of Electrical/Electronic/Programmable Electronic Safety-Related Systems

IEC 62061 Functional Safety of Safety-Related Electrical, Electronic and Programmable Control Systems



ISO 13849-1 (EN 954-1) Safety-Related Parts of Control Systems

IEC 60947-1 Low Voltage Switchgear – General Rules

IEC 60947-5-1 Low Voltage Switchgear – Electromechanical Control Circuit Devices

IEC 60947-5-5 Low Voltage Switchgear – Electrical Emergency Stop Device with Mechanical Latching Function

IEC 60529 Degrees of Protection Provided by Enclosures

## Banner Engineering Corp Limited Warranty

---

Banner Engineering Corp. warrants its products to be free from defects in material and workmanship for one year following the date of shipment. Banner Engineering Corp. will repair or replace, free of charge, any product of its manufacture which, at the time it is returned to the factory, is found to have been defective during the warranty period. This warranty does not cover damage or liability for misuse, abuse, or the improper application or installation of the Banner product.

THIS LIMITED WARRANTY IS EXCLUSIVE AND IN LIEU OF ALL OTHER WARRANTIES WHETHER EXPRESS OR IMPLIED (INCLUDING, WITHOUT LIMITATION, ANY WARRANTY OF MERCHANTABILITY OR FITNESS FOR A PARTICULAR PURPOSE), AND WHETHER ARISING UNDER COURSE OF PERFORMANCE, COURSE OF DEALING OR TRADE USAGE.

This Warranty is exclusive and limited to repair or, at the discretion of Banner Engineering Corp., replacement. IN NO EVENT SHALL BANNER ENGINEERING CORP. BE LIABLE TO BUYER OR ANY OTHER PERSON OR ENTITY FOR ANY EXTRA COSTS, EXPENSES, LOSSES, LOSS OF PROFITS, OR ANY INCIDENTAL, CONSEQUENTIAL OR SPECIAL DAMAGES RESULTING FROM ANY PRODUCT DEFECT OR FROM THE USE OR INABILITY TO USE THE PRODUCT, WHETHER ARISING IN CONTRACT OR WARRANTY, STATUTE, TORT, STRICT LIABILITY, NEGLIGENCE, OR OTHERWISE.

Banner Engineering Corp. reserves the right to change, modify or improve the design of the product without assuming any obligations or liabilities relating to any product previously manufactured by Banner Engineering Corp.