

# TL50C Compact Tower Light



## Datasheet

Multi-Color General-Purpose or Audible Indicators



- Bright, uniform lighted segments at only half the height of the standard TL50 models
- Rugged, cost-effective, and easy-to-install multi-segment indicators
- Illuminated segments provide easy-to-see operator guidance and indication of equipment status
- Up to 7 stacked colors available
- Available in black or light gray housing
- Audible models available with standard, sealed, or omni-directional audible element
- Compact devices are completely self-contained, no controller needed
- 12 V dc to 30 V dc or 24 V ac operation
- No assembly required

## Models

Non-Audible Models <sup>1</sup>	# of LED Colors	LED Colors <sup>2</sup>	Connection <sup>3</sup>
TL50CRQ	1	Red	Integral 4-pin M12/Euro-style quick disconnect
TL50CGRQ	2	Green, Red	
TL50CGYRQ	3	Green, Yellow, Red	
TL50CBGYRQ	4	Blue, Green, Yellow, Red	Integral 5-pin M12/Euro-style quick disconnect
TL50CWBGYRQ	5	White, Blue, Green, Yellow, Red	Integral 8-pin M12/Euro-style quick disconnect

Standard Audible Models <sup>1</sup>	# of LED Colors	LED Colors <sup>2</sup>	Connection <sup>3</sup>
TL50CRAQ	1	Red	Integral 4-pin M12/Euro-style quick disconnect
TL50CGRAQ	2	Green, Red	
TL50CGYRAQ	3	Green, Yellow, Red	Integral 5-pin M12/Euro-style quick disconnect
TL50CBGYRAQ	4	Blue, Green, Yellow, Red	Integral 8-pin M12/Euro-style quick disconnect
TL50CWBGYRAQ	5	White, Blue, Green, Yellow, Red	

Sealed Audible Models <sup>1</sup>			# of LED Colors	LED Colors <sup>2</sup>	Connection <sup>3</sup>
Continuous	Pulsed at 1.6 Hz	Staccato			
TL50CRALSQ	TL50CRALS3Q	TL50CRALS4Q	1	Red	Integral 4-pin M12/Euro-style quick disconnect
TL50CGRALSQ	TL50CGRALS3Q	TL50CGRALS4Q	2	Green, Red	
TL50CGYRALSQ	TL50CGYRALS3Q	TL50CGYRALS4Q	3	Green, Yellow, Red	Integral 5-pin M12/Euro-style quick disconnect
TL50CBGYRALSQ	TL50CBGYRALS3Q	TL50CBGYRALS4Q	4	Blue, Green, Yellow, Red	Integral 8-pin M12/Euro-style quick disconnect
TL50CWBGYRALSQ	TL50CWBGYRALS3Q	TL50CWBGYRALS4Q	5	White, Blue, Green, Yellow, Red	

- <sup>1</sup>
- Models with black housing are listed. For gray housing, add the suffix "C" at the end of the cabled model number or before the "Q" in quick disconnect model numbers. For example, TL50CRAC or TL50CRACQ.
- <sup>2</sup>
- All models have Bimodal (NPN or PNP) inputs.
  - The first color listed is the bottom color, going up in successive order.
  - Available colors include: Green (G), Red (R), Yellow (Y), Blue (B), Orange (O), White (W), Turquoise (T), Violet (V), Magenta (M) and Sky Blue (S).
  - Contact Banner Engineering for other colors and color combinations.
- <sup>3</sup>
- To order the 150 mm (6 in) PVC cable model with a M12/Euro-style quick disconnect, replace the suffix "Q" with "QP" in the model number. For example, TL50CRAQP.
  - To order the 2 m (6.5 ft) PVC cable model, omit the suffix "Q" in the model number. For example, TL50CRA.
  - Models with a quick disconnect require a mating cordset.



Omni-Directional Sealed Audible Models <sup>1</sup>			# of LED Colors	LED Colors <sup>2</sup>	Connection <sup>3</sup>
Continuous	Pulsed at 1.6 Hz	Staccato			
TL50CRAOSQ	TL50CRAOS3Q	TL50CRAOS4Q	1	Red	Integral 4-pin M12/Euro-style quick disconnect
TL50CGRAOSQ	TL50CGRAOS3Q	TL50CGRAOS4Q	2	Green, Red	
TL50CGYRAOSQ	TL50CGYRAOS3Q	TL50CGYRAOS4Q	3	Green, Yellow, Red	Integral 5-pin M12/Euro-style quick disconnect
TL50CBGYRAOSQ	TL50CBGYRAOS3Q	TL50CBGYRAOS4Q	4	Blue, Green, Yellow, Red	Integral 8-pin M12/Euro-style quick disconnect
TL50CWBGYRAOSQ	TL50CWBGYRAOS3Q	TL50CWBGYRAOS4Q	5	White, Blue, Green, Yellow, Red	

Omni-Directional Sealed Audible Models with Intensity Adjustment <sup>1</sup>			# of LED Colors	LED Colors <sup>2</sup>	Connection <sup>3</sup>
Continuous	Pulsed at 1.6 Hz	Staccato			
TL50CRAOSIQ	TL50CRAOS3IQ	TL50CRAOS4IQ	1	Red	Integral 4-pin M12/Euro-style quick disconnect
TL50CGRAOSIQ	TL50CGRAOS3IQ	TL50CGRAOS4IQ	2	Green, Red	
TL50CGYRAOSIQ	TL50CGYRAOS3IQ	TL50CGYRAOS4IQ	3	Green, Yellow, Red	Integral 5-pin M12/Euro-style quick disconnect
TL50CBGYRAOSIQ	TL50CBGYRAOS3IQ	TL50CBGYRAOS4IQ	4	Blue, Green, Yellow, Red	Integral 8-pin M12/Euro-style quick disconnect
TL50CWBGYRAOSIQ	TL50CWBGYRAOS3IQ	TL50CWBGYRAOS4IQ	5	White, Blue, Green, Yellow, Red	

### Wiring Diagrams — 4-Pin Models with 1 to 3 Segments

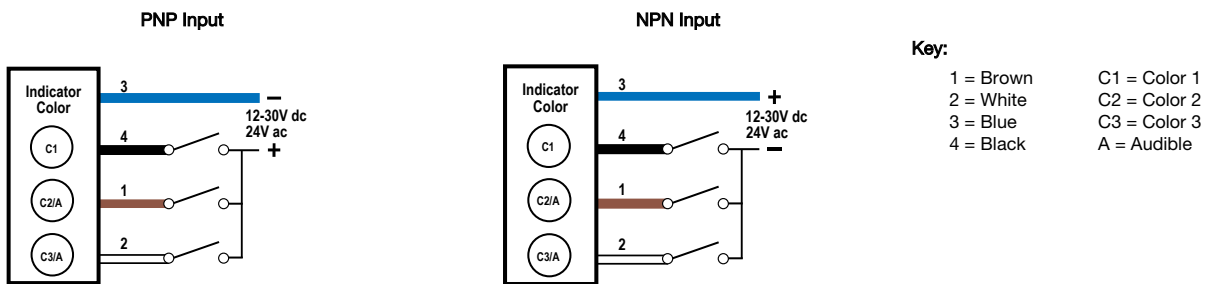

Pins 1 and 2 could activate the corresponding color or the audible function, if available.

### Wiring Diagrams — 5-Pin Models with 4 Segments

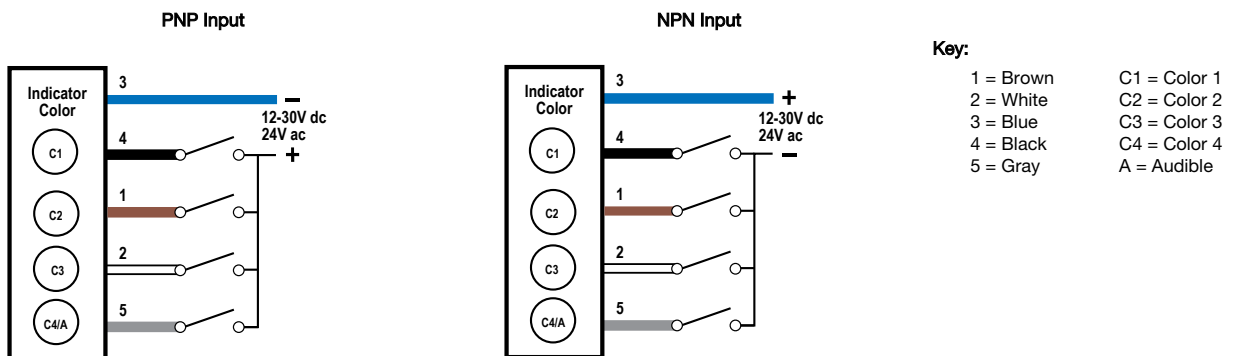

Pin 5 could activate the corresponding color or the audible function, if available.

## Wiring Diagrams — 8-Pin Models with 5 to 7 Segments

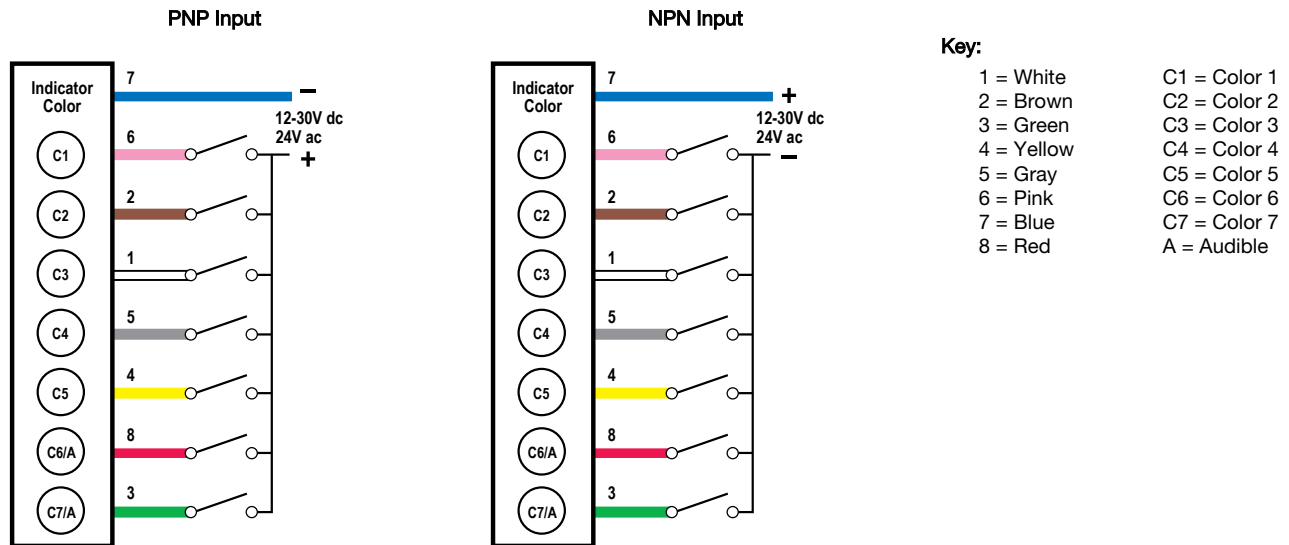

Pins 3 and 8 can activate the corresponding color or the audible function, if available.

## Specifications

### Supply Voltage and Current

12 V dc to 30 V dc; or 24 V ac ( $\pm 3$  V) at 50 Hz to 60 Hz

#### Indicators—maximum current per LED color:

- 135 mA at 12 V dc
- 45 mA at 30 V dc
- 60 mA at 24 V ac

**Standard Audible Alarm:** 25 mA maximum current

**Sealed Audible Alarm:** 35 mA maximum current

**Omni-Directional Sealed Audible Alarm:** 45 mA maximum current

### Supply Protection Circuitry

Protected against transient voltages

### Input Response Time

Indicator On/Off: 10 milliseconds maximum

### Audible Alarm

**Standard Audible Alarm:** 2.7 kHz  $\pm$  500 Hz oscillation frequency; maximum intensity 92 dB at 1 m (3.3 ft) (typical)

**Sealed Audible Alarm:** 2.9 kHz  $\pm$  250 Hz oscillation frequency; maximum intensity 94 dB at 1 m (3.3 ft) (typical)

**Omni-Directional Sealed Audible Alarm:** 2.1 kHz  $\pm$  250 Hz oscillation frequency; maximum intensity 99 dB at 1 m (3.3 ft) (typical)

**Omni-Directional Sealed Audible Alarm with Intensity Adjustment:** 2.1 kHz  $\pm$  250 Hz oscillation frequency; maximum intensity 95 dB at 1 m (3.3 ft) (typical)

### Audible Adjustment

**Standard Audible Alarm:** Unscrew the cover (up to 1.5 turns maximum) to adjust the audible intensity. (Do not exceed 1.5 turns or the cover may detach during operation.) For maximum intensity, rotate the center plug 180° counterclockwise to remove it.

**Sealed Audible Alarm and Omni-Directional Sealed Audible Alarm with Intensity Adjustment:** Rotate the front cover until the desired intensity is reached.

#### Typical Reduction in Sound Intensity with Audible Adjustment (maximum to minimum)

- **Standard Audible:** 30 dB
- **Sealed Audible:** 20 dB
- **Omni-Directional Sealed Audible:** 12 dB

### Indicators

LEDs are independently selected; 1 to 7 colors depending on model

### Indicator Characteristics

Color	Dominant Wavelength (nm) or Color Temperature (CCT)	Color Coordinates <sup>#</sup>		Lumen Output (Typical at 25 °C)
		x	y	
Green	528 nm	-	-	27.0
Red	625 nm	-	-	9.0
Yellow	590 nm	-	-	6.0
Blue	470 nm	-	-	4.5
Orange	608 nm	-	-	18.5
White	6000 K	-	-	25.0
Turquoise	-	0.19	0.37	6.5
Violet	-	0.20	0.08	3.0
Magenta	-	0.35	0.15	3.5
Sky Blue	-	0.19	0.26	14.5

### Operating Conditions

**Non-Audible:** -40 °C to +50 °C (-40 °F to +122 °F)

**Standard and Sealed Audible:** -20 °C to +50 °C (-4 °F to +122 °F)

95% at +50 °C maximum relative humidity (non-condensing)

### Environmental Rating

UL Type 4X Indoor and UL Type 13

**Non-Audible and Sealed Audible:** IEC IP67

**Standard Audible:** IEC IP50

<sup>#</sup> Refer to CIE 1931 chromaticity diagram or color chart, to show equivalent color with indicated color coordinates.

**Connections**

Integral 4-pin, 5-pin, or 8-pin M12/Euro-style quick disconnect, or 2 m (6.5 ft) integral PVC cable, depending on model  
Models with a quick disconnect require a mating cordset

**Construction**

**Bases and Covers:** ABS  
**Light Segment:** Polycarbonate

**Vibration and Mechanical Shock**

Meets IEC 60068-2-6 requirements (Vibration: 10 Hz to 55 Hz, 1.0 mm amplitude, 5 minutes sweep, 30 minutes dwell)  
Meets IEC 60068-2-27 requirements (Shock: 30G 11 ms duration, half sine wave)

**Certifications**



**Required Overcurrent Protection**



**WARNING:** Electrical connections must be made by qualified personnel in accordance with local and national electrical codes and regulations.

Overcurrent protection is required to be provided by end product application per the supplied table.  
Overcurrent protection may be provided with external fusing or via Current Limiting, Class 2 Power Supply.  
Supply wiring leads < 24 AWG shall not be spliced.  
For additional product support, go to [www.bannerengineering.com](http://www.bannerengineering.com).

Supply Wiring (AWG)	Required Overcurrent Protection (Amps)
20	5.0
22	3.0
24	2.0
26	1.0
28	0.8
30	0.5

**Dimensions**

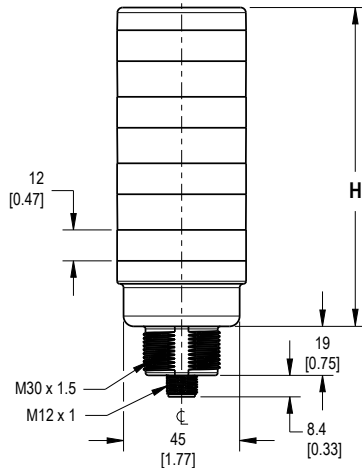

# of Colors	Tower Height (H)			
	Non-Audible	Standard Audible*	Sealed Audible	Omni-Directional Sealed Audible
1	46.2 mm (1.8 in)	77.1 mm (3.1 in)	100.2 mm (4.0 in)	114.2 mm (4.48 in)
2	72.0 mm (2.83 in)	102.9 mm (4.1 in)	126.0 mm (5.0 in)	140.0 mm (5.5 in)
3	97.8 mm (3.85 in)	128.7 mm (5.1 in)	151.8 mm (6.0 in)	165.8 mm (6.5 in)
4	123.6 mm (4.9 in)	154.5 mm (6.1 in)	177.6 mm (7.0 in)	191.6 mm (7.54 in)
5	149.4 mm (5.9 in)	180.3 mm (7.1 in)	203.4 mm (8.0 in)	217.4 mm (8.56 in)
6	175.2 mm (6.9 in)	206.1 mm (8.1 in)	229.2 mm (9.0 in)	243.4 mm (9.58 in)
7	201.0 mm (7.9 in)	-	-	-

\*Tower height (H) with top unscrewed approximately 3.5 mm to allow sound to escape

All measurements are listed in millimeters [inches], unless noted otherwise.

**Accessories**

**Cordsets**

4-Pin Threaded M12/Euro-Style Cordsets—Single Ended				
Model	Length	Style	Dimensions	Pinout (Female)
MQDC-406	1.83 m (6 ft)	Straight		
MQDC-415	4.57 m (15 ft)			
MQDC-430	9.14 m (30 ft)			
MQDC-450	15.2 m (50 ft)			

1 = Brown  
2 = White  
3 = Blue  
4 = Black

5-Pin Threaded M12/Euro-Style Cordsets—Single Ended				
Model	Length	Style	Dimensions	Pinout (Female)
MQDC1-501.5	0.50 m (1.5 ft)	Straight		 1 = Brown 2 = White 3 = Blue 4 = Black 5 = Gray
MQDC1-506	1.83 m (6 ft)			
MQDC1-515	4.57 m (15 ft)			
MQDC1-530	9.14 m (30 ft)			
MQDC1-506RA	1.83 m (6 ft)	Right-Angle		
MQDC1-515RA	4.57 m (15 ft)			
MQDC1-530RA	9.14 m (30 ft)			

8-Pin Threaded M12/Euro-Style Cordsets with Open-Shield				
Model	Length	Style	Dimensions	Pinout (Female)
MQDC2S-806	1.83 m (6 ft)	Straight		 1 = White 2 = Brown 3 = Green 4 = Yellow 5 = Gray 6 = Pink 7 = Blue 8 = Red
MQDC2S-815	4.57 m (15 ft)			
MQDC2S-830	9.14 m (30 ft)			
MQDC2S-850	15.2 m (50 ft)			
MQDC2S-806RA	1.83 m (6 ft)	Right-Angle		
MQDC2S-815RA	4.57 m (15 ft)			
MQDC2S-830RA	9.14 m (30 ft)			
MQDC2S-850RA	15.2 m (50 ft)			

## Mounting Brackets

All measurements are listed in millimeters [inches], unless noted otherwise.

### SMB30A

- Right-angle bracket with curved slot for versatile orientation
- Clearance for M6 (¼ in) hardware
- Mounting hole for 30 mm sensor
- 12-ga. stainless steel

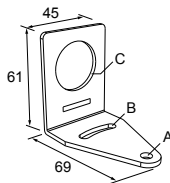

**Hole center spacing:** A to B=40

**Hole size:** A=ø 6.3, B= 27.1 x 6.3, C=ø 30.5

### SMB30FA

- Swivel bracket with tilt and pan movement for precise adjustment
- Mounting hole for 30 mm sensor
- 12-ga. 304 stainless steel
- Easy sensor mounting to extrude rail T-slot
- Metric and inch size bolt available

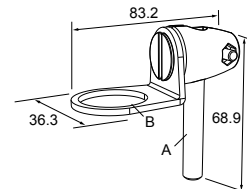

**Bolt thread:** SMB30FA, A= 3/8 - 16 x 2 in; SMB30FAM10, A= M10 - 1.5 x 50

**Hole size:** B= ø 30.1

**SMB30MM**

- 12-ga. stainless steel bracket with curved mounting slots for versatile orientation
- Clearance for M6 (1/4 in) hardware
- Mounting hole for 30 mm sensor

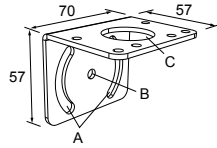

**Hole center spacing:** A = 51, A to B = 25.4  
**Hole size:** A = 42.6 x 7, B =  $\phi$  6.4, C =  $\phi$  30.1

**SMBAMS30P**

- Flat SMBAMS series bracket
- 30 mm hole for mounting sensors
- Articulation slots for 90°+ rotation
- 12-ga. 300 series stainless steel

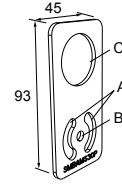

**Hole center spacing:** A=26.0, A to B=13.0  
**Hole size:** A=26.8 x 7.0, B= $\phi$  6.5, C= $\phi$  31.0

**SMBAMS30RA**

- Right-angle SMBAMS series bracket
- 30 mm hole for mounting sensors
- Articulation slots for 90°+ rotation
- 12-ga. (2.6 mm) cold-rolled steel

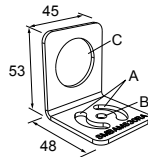

**Hole center spacing:** A=26.0, A to B=13.0  
**Hole size:** A=26.8 x 7.0, B= $\phi$  6.5, C= $\phi$  31.0

**SMB30SC**

- Swivel bracket with 30 mm mounting hole for sensor
- Black reinforced thermoplastic polyester
- Stainless steel mounting and swivel locking hardware included

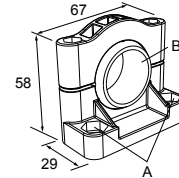

**Hole center spacing:** A= $\phi$  50.8  
**Hole size:** A= $\phi$  7.0, B= $\phi$  30.0

**LMBE12RA35**

- Direct mounting of stand-off pipe, with common bracket type
- Zinc-plated steel
- 1/2-14 NPSM nut
- Mounting distance from the wall to the center of the 1/2-14 NPSM nut is 35 mm

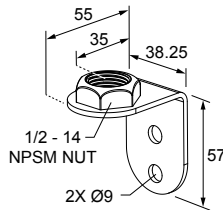

Hole center spacing: 20.0

**LMBE12RA45**

- Direct mounting of stand-off pipe, with common bracket type
- Zinc-plated steel
- 1/2-14 NPSM nut
- Mounting distance from the wall to the center of the 1/2-14 NPSM nut is 45 mm

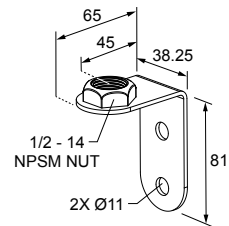

Hole center spacing: 35.0

LMB Sealed Right-Angle Bracket

Model	Description	Construction	
LMB30RA	<b>Direct-Mount Models:</b> Bracket kit with base, 30 mm adapter, set screw, fasteners, O-rings, and gaskets.	Black polycarbonate	
LMB30RAC		Gray polycarbonate	
LMBE12RA	<b>Pipe-Mount Models:</b> Bracket kit with base, 1/2-14 pipe adapter, set screw, fasteners, O-rings, and gaskets. For use with stand-off pipe (listed and sold separately).	Black polycarbonate	
LMBE12RAC		Gray polycarbonate	

Elevated Mount System

Model	Features			Components									
SA-M30TE12 - Black Acetal	<ul style="list-style-type: none"> <li>• Streamlined black acetal or white UHMW stand-off pipe adapter/cover</li> <li>• Connects between 30 mm light base and 1/2 in. NPSM/DN15 pipe</li> <li>• Mounting hardware included</li> </ul>												
SA-M30TE12C - White UHMW													
<table border="1"> <tr> <td>Polished 304 Stainless Steel</td> <td>Black Anodized Aluminum</td> <td>Clear Anodized Aluminum</td> </tr> <tr> <td>SOP-E12-150SS 150 mm (6 in) long</td> <td>SOP-E12-150A 150 mm (6 in) long</td> <td>SOP-E12-150AC 150 mm (6 in) long</td> </tr> <tr> <td>SOP-E12-300SS 300 mm (12 in) long</td> <td>SOP-E12-300A 300 mm (12 in) long</td> <td>SOP-E12-300AC 300 mm (12 in) long</td> </tr> </table>	Polished 304 Stainless Steel	Black Anodized Aluminum	Clear Anodized Aluminum	SOP-E12-150SS 150 mm (6 in) long	SOP-E12-150A 150 mm (6 in) long	SOP-E12-150AC 150 mm (6 in) long	SOP-E12-300SS 300 mm (12 in) long	SOP-E12-300A 300 mm (12 in) long	SOP-E12-300AC 300 mm (12 in) long	<ul style="list-style-type: none"> <li>• Elevated-use stand-off pipe (1/2 in. NPSM/DN15)</li> <li>• Polished 304 stainless steel, black anodized aluminum, or clear anodized aluminum surface</li> <li>• 1/2 in. NPT thread at both ends</li> <li>• Compatible with most industrial environments</li> </ul>			
Polished 304 Stainless Steel	Black Anodized Aluminum	Clear Anodized Aluminum											
SOP-E12-150SS 150 mm (6 in) long	SOP-E12-150A 150 mm (6 in) long	SOP-E12-150AC 150 mm (6 in) long											
SOP-E12-300SS 300 mm (12 in) long	SOP-E12-300A 300 mm (12 in) long	SOP-E12-300AC 300 mm (12 in) long											

Model			Features	Components
<b>SOP-E12-900SS</b> 900 mm (36 in) long	<b>SOP-E12-900A</b> 900 mm (36 in) long	<b>SOP-E12-900AC</b> 900 mm (36 in) long		
<b>SA-E12M30</b> - Black Acetal			<ul style="list-style-type: none"> <li>Streamlined black acetal or white UHMW mounting base adapter/cover</li> <li>Connects between ½ in. NPSM/DN15 pipe and 30 mm (1-3/16 in) drilled hole</li> <li>Mounting hardware included</li> </ul>	
<b>SA-E12M30C</b> - White UHMW				

## Pipe Mounting Flange

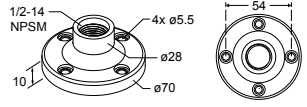
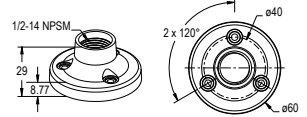
Pipe Mounting Flange			
Model	Features	Construction	
<b>SA-F12</b>	<ul style="list-style-type: none"> <li>Elevated-use stand-off pipes (½ in, NPSM/DN15)</li> <li>M5 mounting hardware and nitrile gasket included</li> </ul>	Die-cast zinc base with black paint	
<b>SA-F12-3</b>	<ul style="list-style-type: none"> <li>Elevated-use stand-off pipes (½ in, NPSM/DN15)</li> <li>M4 mounting hardware and nitrile blend gasket included</li> </ul>	Black Polycarbonate	

## Banner Engineering Corp Limited Warranty

Banner Engineering Corp. warrants its products to be free from defects in material and workmanship for one year following the date of shipment. Banner Engineering Corp. will repair or replace, free of charge, any product of its manufacture which, at the time it is returned to the factory, is found to have been defective during the warranty period. This warranty does not cover damage or liability for misuse, abuse, or the improper application or installation of the Banner product.

**THIS LIMITED WARRANTY IS EXCLUSIVE AND IN LIEU OF ALL OTHER WARRANTIES WHETHER EXPRESS OR IMPLIED (INCLUDING, WITHOUT LIMITATION, ANY WARRANTY OF MERCHANTABILITY OR FITNESS FOR A PARTICULAR PURPOSE), AND WHETHER ARISING UNDER COURSE OF PERFORMANCE, COURSE OF DEALING OR TRADE USAGE.**

This Warranty is exclusive and limited to repair or, at the discretion of Banner Engineering Corp., replacement. **IN NO EVENT SHALL BANNER ENGINEERING CORP. BE LIABLE TO BUYER OR ANY OTHER PERSON OR ENTITY FOR ANY EXTRA COSTS, EXPENSES, LOSSES, LOSS OF PROFITS, OR ANY INCIDENTAL, CONSEQUENTIAL OR SPECIAL DAMAGES RESULTING FROM ANY PRODUCT DEFECT OR FROM THE USE OR INABILITY TO USE THE PRODUCT, WHETHER ARISING IN CONTRACT OR WARRANTY, STATUTE, TORT, STRICT LIABILITY, NEGLIGENCE, OR OTHERWISE.**

Banner Engineering Corp. reserves the right to change, modify or improve the design of the product without assuming any obligations or liabilities relating to any product previously manufactured by Banner Engineering Corp. Any misuse, abuse, or improper application or installation of this product or use of the product for personal protection applications when the product is identified as not intended for such purposes will void the product warranty. Any modifications to this product without prior express approval by Banner Engineering Corp will void the product warranties. All specifications published in this document are subject to change; Banner reserves the right to modify product specifications or update documentation at any time. Specifications and product information in English supersede that which is provided in any other language. For the most recent version of any documentation, refer to: [www.bannerengineering.com](http://www.bannerengineering.com).

For patent information, see [www.bannerengineering.com/patents](http://www.bannerengineering.com/patents).