

WLS27 Dual Color LED Strip Light



Instruction Manual

Banner's WLS27 LED Strip Light has a sturdy aluminum housing and is encased in a shatterproof, UV-stabilized, copolyester shell, making it ideal for harsh indoor and outdoor applications. Having two colors in one device make these ideal for mobile vehicle, machine status, and vision lighting applications.

- Rugged, water-resistant DIN IP69K rating
- Available in eight lengths from 145 mm to 1130 mm
- Daisy chain power to multiple lights
- Automatic temperature protection built into the unit. Above 50 °C, the light dims to manage heat and protect product lifetime.



Stand-Alone Light or End Light in a Cascade



First or Middle of a Cascade

These Work Light Strips are available as either stand-alone models, or as cascade models that can be "daisy-chained" together for a continuous length of lighting, with a minimum of wiring.

Stand-alone models have a male quick disconnect at one end of power connection and no connections at opposite end. A stand-alone model may be used as the last in the cascade series.

Cascade models have a male quick disconnect at one end of power connection, and a female QD at the opposite end for connecting to other lights in the cascade. A double-ended accessory cordset must be used between each pair of lights in a cascade.

Models

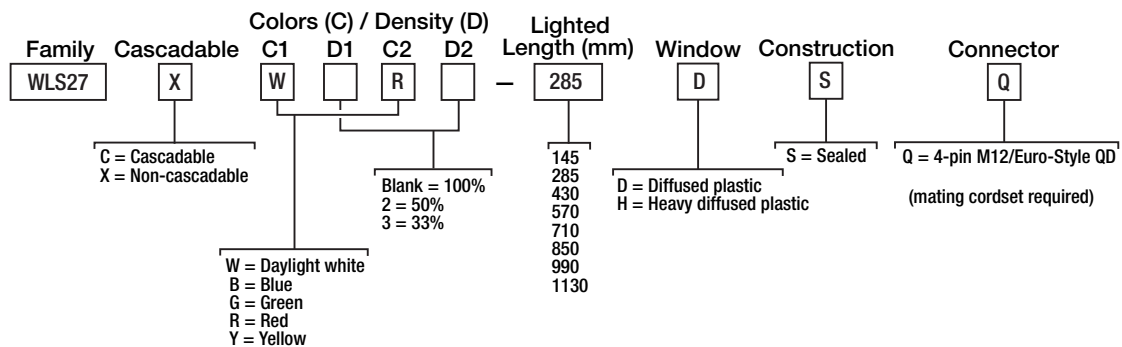

Density (D) is defined by the quantity of LEDs populated on the circuit. For example, at 100% density, there are 18 LEDs per 285 mm, and at 50% density, there are 9 LEDs per 285 mm. The lumen output decreases proportionally with density.

Sample Model	Description
WLS27XWR-285DSQ	Non Cascade, White (100% Density), Red (100% Density), 285 mm, 4-pin M12/Euro-style quick disconnect connector
WLS27CWR-850DSQ	Cascadable, White (100% Density), Red (100% Density), 850 mm, 4-pin M12/Euro-style quick disconnect connector
WLS27XWR2-285DSQ	Non-Cascade, White (100% Density), Red (50% Density), 285 mm, 4-pin M12/Euro-style quick disconnect connector



Wiring Diagrams

Male	Female	Pin	Wire Color	Connection
		1	brown	Color 1: 12 to 30 V dc
		3	blue	dc common
		4	black	Color 2: 12 to 30 V dc (color 2 overrides color 1)
		2	white	Not used

Specifications

Supply Voltage

12 V dc to 30 V dc
Use only with suitable Class 2 power supply (UL) or a SELV power supply (CE)

Light Length (mm)	Typical Current (A)			Max. Current A
	12 V dc	24 V dc	30 V dc	
145	0.33	0.15	0.12	0.4
285	0.66	0.30	0.24	0.8
430	1.01	0.46	0.36	1.2
570	1.36	0.61	0.48	1.6
710	1.75	0.77	0.60	2.0
850	2.13	0.92	0.73	2.4
990	2.59	1.08	0.85	2.8
1130	3.04	1.24	0.97	3.2

Operating Temperature

-40 °C to +70 °C (-40 °F to +158 °F)
Light output begins to decrease above 50 °C (122 °F) and will be approximately 65% of max intensity at 60 °C (140 °F) and 30% of max intensity at 70 °C (158 °F)

Environmental Rating

Rated IEC IP66, IEC IP67, and DIN IP69K



Note: Do not spray cable with high-pressure sprayer, or cable damage will result.

Application Notes

When connecting cascadable lights in series it is important not to exceed maximum current limitations:
Maximum length of light at 12 V dc: 1.4 m (4.6 ft)
Maximum length of light at 24 V dc: 3.0 m (9.8 ft)
Maximum length of light at 30 V dc: 3.1 m (10.2 ft)

Light Characteristics - Daylight White

Color Temperature (CCT): 4700-5300K
Lumen output: 475 (± 5%) per 285 mm, typical at 25 °C (77 °F)
CRI: 83, typical

Light Characteristics - Other Colors

Color	Typical Wavelength or Color Temperature	Typical Intensity (per 285 mm)
Red	625 nm	200
Yellow	590 nm	150
Green	525 nm	300
Blue	470 nm	110

Construction

Copolyester outer housing

Mounting

Bracket LMBWLS27EC included (2 for lights up to 570 mm or 3 for lights 710 mm and longer)

Connections

Integral 4-pin M12/Euro-style quick disconnect
Models with a quick disconnect require a mating cordset

Vibration and Mechanical Shock

Vibration: 10 Hz to 55 Hz, 1.0 mm peak-to-peak amplitude per IEC 60068-2-6
Shock: 15G 11 ms duration, half sine wave per IEC 60068-2-27

Certifications



Dimensions

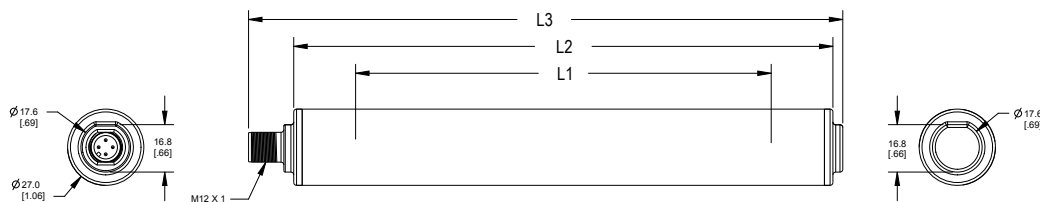

Figure 1. Quick Disconnect Models

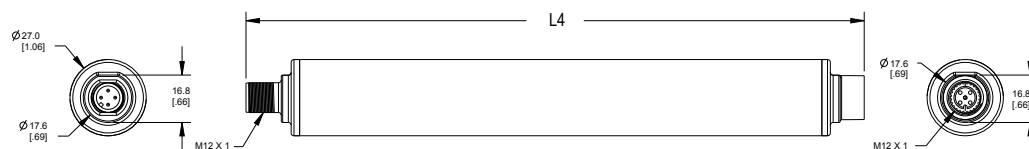

Figure 2. Cascade Models

Models	L1	L2	L3	L4
WLS27..145..	145 mm (5.7 in)	189 mm (7.4 in)	208.5 mm (8.2 in)	217 mm (8.5 in)
WLS27..285..	286 mm (11.3 in)	330 (13 in)	349.5 mm (13.8 in)	358 mm (14.1 in)
WLS27..430..	427 mm (16.8 in)	471 mm (18.5 in)	490.5 mm (13.3 in)	499 mm (19.6 in)
WLS27..570..	569 mm (22.4 in)	612 mm (24.1 in)	631.5 mm (24.9 in)	640 mm (25.2 in)
WLS27..710..	708 mm (27.9 in)	752 mm (29.6 in)	771.5 mm (30.4 in)	780 mm (30.7 in)
WLS27..850..	849 mm (33.4 in)	893 mm (35.2 in)	912.5 mm (35.9 in)	921 mm (36.2 in)
WLS27..990..	991 mm (39 in)	1035 mm (40.8 in)	1054.5 mm (41.5 in)	1063 mm (41.8 in)
WLS27..1130..	1120 mm (44.1 in)	1164 mm (45.8 in)	1183.5 mm (46.4 in)	1192 mm (46.9 in)

Performance

For models with heavy diffused housing, multiply lumen values by 0.8.

145 mm Models

Polar Candela Distribution

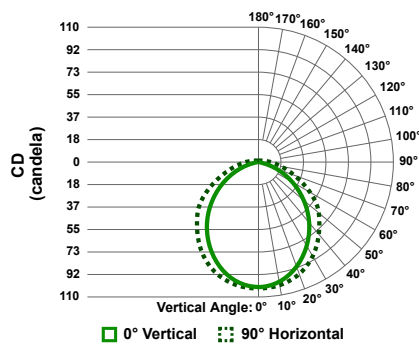

Isolux Pattern

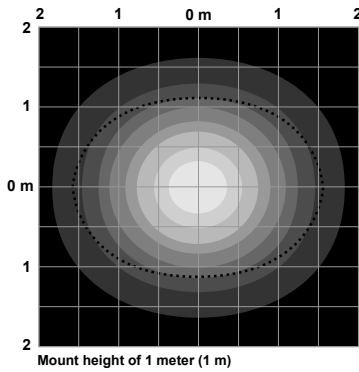

Illuminance at a Distance

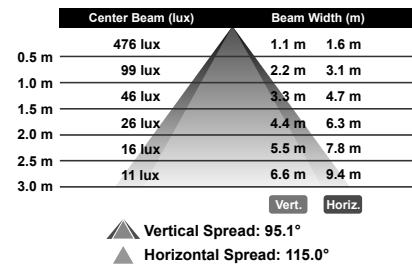

285 mm Models

Polar Candela Distribution

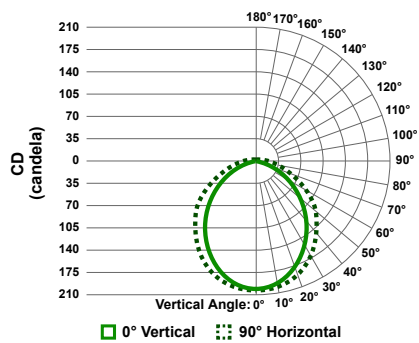

Isolux Pattern

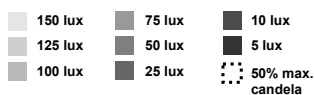
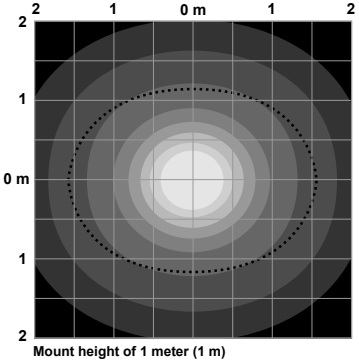

Illuminance at a Distance

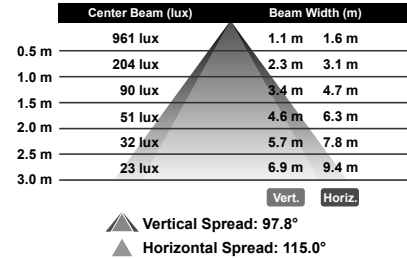

430 mm Models

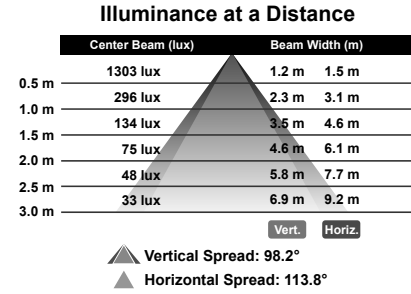
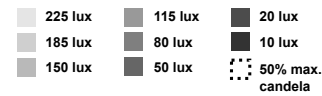
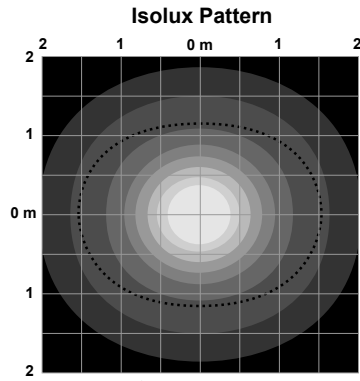
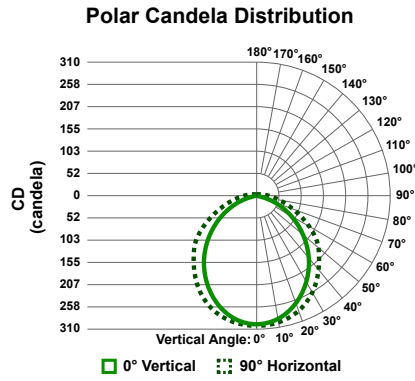

570 mm Models

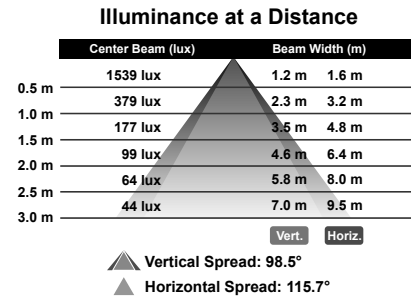
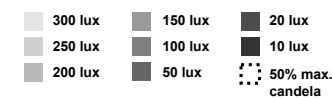
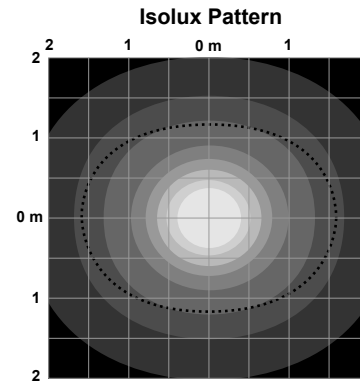
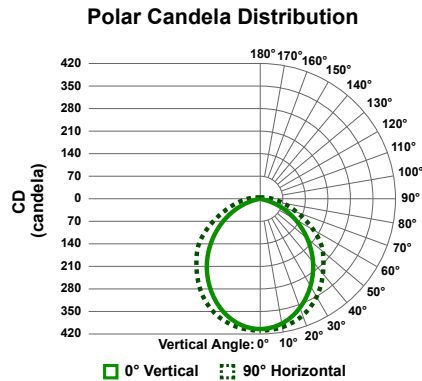

710 mm Models

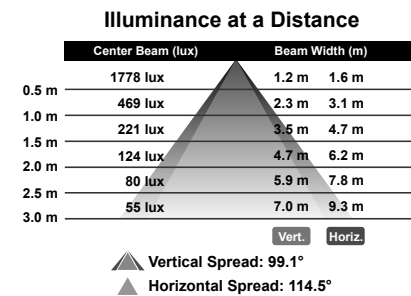
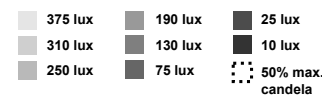
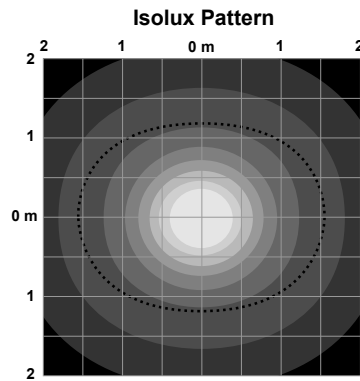
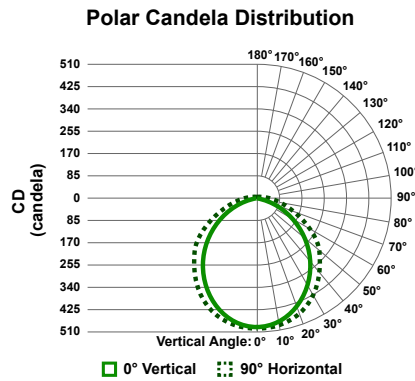

850 mm Models

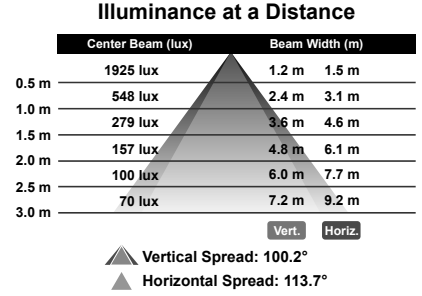
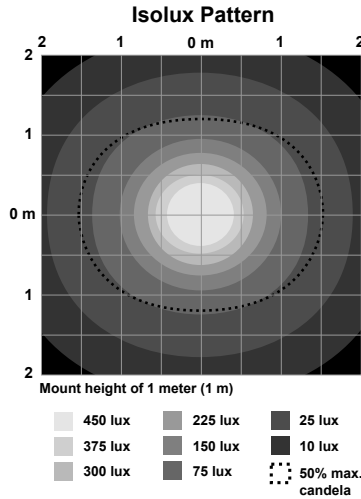
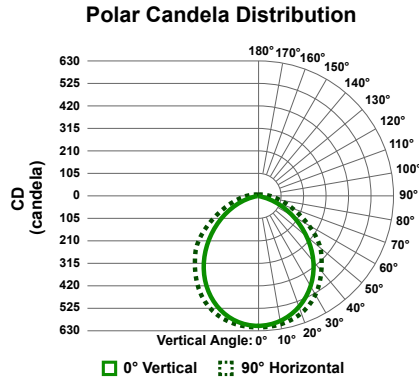

990 mm Models

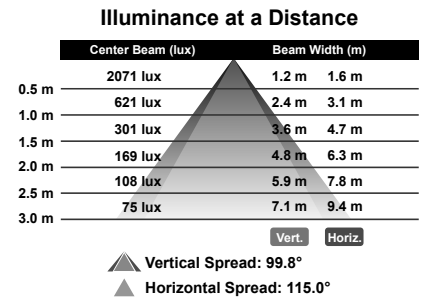
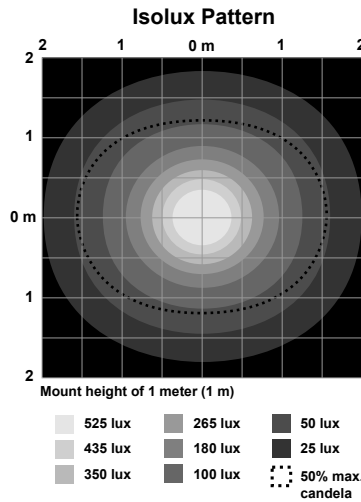
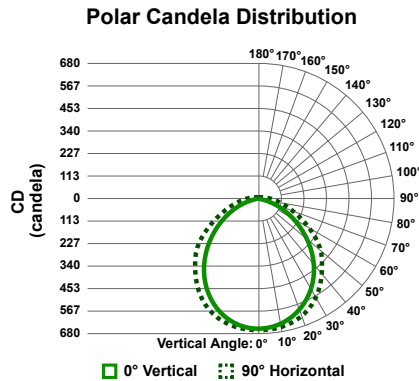

1130 mm Models

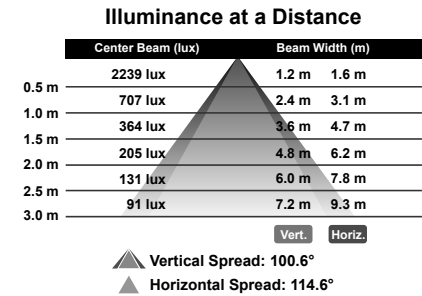
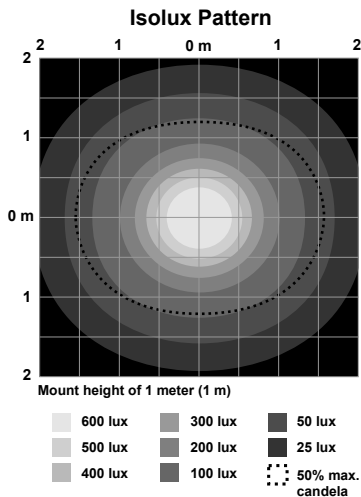
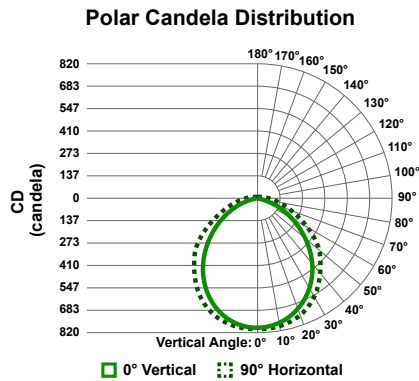

Accessories

Brackets

LMBWLS27EC

- Clear copolyester
- Clearance for M5 or #10 hardware

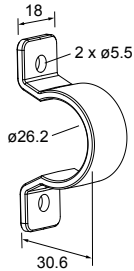

LMBWLS27H

- 300 series stainless steel mounting brackets
- M4 stainless steel hardware included

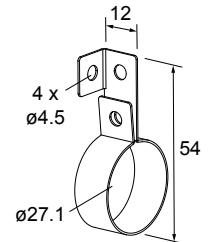

LMBWLS27SP

- Clear copolyester
- Clearance for M5 or #10 hardware
- Snap bracket for light duty applications

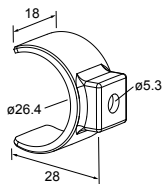

LMBWLS27T

- Stainless steel mounting brackets with rubber grips
- M5 stainless steel hardware included
- Clearance for M5 or #10 hardware

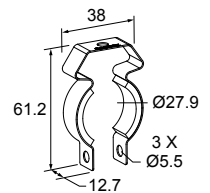

LMBWLS27U

- Clear copolyester
- Clearance for M5 or #10 hardware
- Clamps securely around the light body

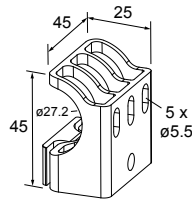

Cordsets

4-Pin Threaded M12/Euro-Style Cordsets—Single Ended				
Model	Length	Style	Dimensions	Pinout (Female)
MQDC-406	1.83 m (6 ft)	Straight		<p>1 = Brown 2 = White 3 = Blue 4 = Black</p>
MQDC-415	4.57 m (15 ft)			
MQDC-430	9.14 m (30 ft)			
MQDC-450	15.2 m (50 ft)			
MQDC-406RA	1.83 m (6 ft)	Right-Angle		
MQDC-415RA	4.57 m (15 ft)			
MQDC-430RA	9.14 m (30 ft)			
MQDC-450RA	15.2 m (50 ft)			

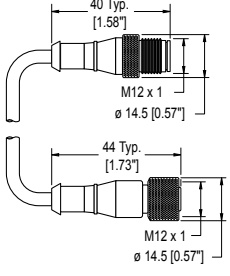
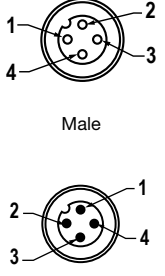
4-Pin Threaded M12/Euro-Style Cordsets—Double Ended				
Model	Length	Style	Dimensions	Pinout
MQDEC-401SS	0.31 m (1 ft)	Male Straight/ Female Straight		Female
MQDEC-403SS	0.91 m (3 ft)			Female
MQDEC-406SS	1.83 m (6 ft)			Female
MQDEC-412SS	3.66 m (12 ft)			Female
MQDEC-420SS	6.10 m (20 ft)			Female
MQDEC-430SS	9.14 m (30 ft)			Female
MQDEC-450SS	15.2 m (50 ft)			Male
				 <p>1 = Brown 2 = White 3 = Blue 4 = Black</p>

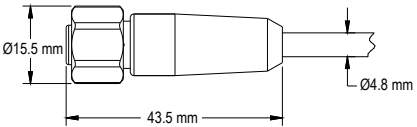
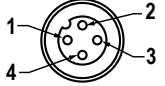
4-Pin Threaded M12/Euro-Style Cordsets—Washdown, Stainless Steel, Single Ended				
Model	Length	Style	Dimensions	Pinout (Female)
MQDC-WDSS-0406	1.83 m (6 ft)	Straight		Female
MQDC-WDSS-0415	4.57 m (15 ft)			Female
MQDC-WDSS-0430	9.14 m (30 ft)			Female
				 <p>1 = Brown 2 = White 3 = Blue 4 = Black</p>

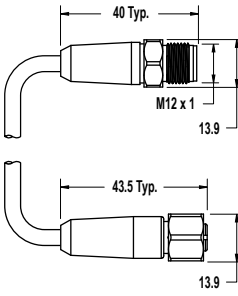
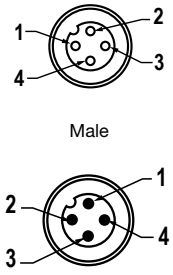
4-Pin Threaded M12/Euro-Style Cordsets—Double Ended, Washdown, Stainless Steel				
Model	Length	Style	Dimensions	Pinout
MQDEC-WDSS-401SS	0.3 m (1 ft)	Male Straight/ Female Straight		Female
MQDEC-WDSS-403SS	0.91 m (3 ft)			Female
MQDEC-WDSS-406SS	1.83 m (6 ft)			Female
MQDEC-WDSS-412SS	3.66 m (12 ft)			Female
				Male
				 <p>1 = Brown 2 = White 3 = Blue 4 = Black</p>

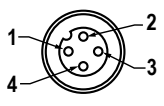
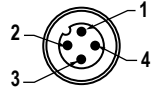
4-Pin Threaded M12/Euro-Style Splitter Cordsets—Flat Junction			
Model	Branches (Female)	Trunk (Male)	Pinout
CSB-M1240M1240	No branch	No trunk	<p>Female</p>  <p>Male</p>  <p>1 = Brown 2 = White 3 = Blue 4 = Black</p>
CSB-M1240M1241	2 x 0.30 m (1 ft)	No trunk	
CSB-M1241M1241		0.30 m (1 ft)	
CSB-M1248M1241		2.50 m (8 ft)	
CSB-M12415M1241		4.57 m (15 ft)	
CSB-M12425M1241		7.60 m (25 ft)	
CSB-UNT425M1241		7.60 m (25 ft) Unterminated	

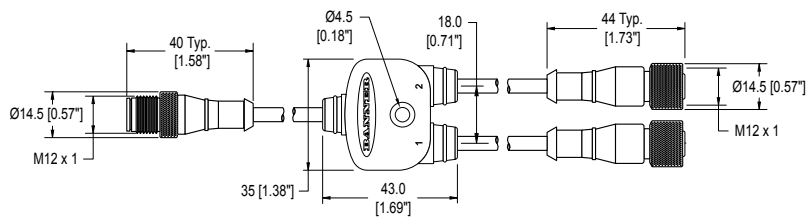

Technical drawing dimensions:
 - Left connector length: 40 Typ. [1.58"]
 - Middle connector length: 35 [1.38"]
 - Middle connector diameter: Ø4.5 [0.18"]
 - Middle connector length: 18.0 [0.71"]
 - Right connector length: 44 Typ. [1.73"]
 - Right connector diameter: Ø14.5 [0.57"]
 - Right connector length: 43.0 [1.69"]
 - All connectors are M12 x 1.

Banner Engineering Corp. Limited Warranty

Banner Engineering Corp. warrants its products to be free from defects in material and workmanship for one year following the date of shipment. Banner Engineering Corp. will repair or replace, free of charge, any product of its manufacture which, at the time it is returned to the factory, is found to have been defective during the warranty period. This warranty does not cover damage or liability for misuse, abuse, or the improper application or installation of the Banner product.

THIS LIMITED WARRANTY IS EXCLUSIVE AND IN LIEU OF ALL OTHER WARRANTIES WHETHER EXPRESS OR IMPLIED (INCLUDING, WITHOUT LIMITATION, ANY WARRANTY OF MERCHANTABILITY OR FITNESS FOR A PARTICULAR PURPOSE), AND WHETHER ARISING UNDER COURSE OF PERFORMANCE, COURSE OF DEALING OR TRADE USAGE.

This Warranty is exclusive and limited to repair or, at the discretion of Banner Engineering Corp., replacement. **IN NO EVENT SHALL BANNER ENGINEERING CORP. BE LIABLE TO BUYER OR ANY OTHER PERSON OR ENTITY FOR ANY EXTRA COSTS, EXPENSES, LOSSES, LOSS OF PROFITS, OR ANY INCIDENTAL, CONSEQUENTIAL OR SPECIAL DAMAGES RESULTING FROM ANY PRODUCT DEFECT OR FROM THE USE OR INABILITY TO USE THE PRODUCT, WHETHER ARISING IN CONTRACT OR WARRANTY, STATUTE, TORT, STRICT LIABILITY, NEGLIGENCE, OR OTHERWISE.**

Banner Engineering Corp. reserves the right to change, modify or improve the design of the product without assuming any obligations or liabilities relating to any product previously manufactured by Banner Engineering Corp. Any misuse, abuse, or improper application or installation of this product or use of the product for personal protection applications when the product is identified as not intended for such purposes will void the product warranty. Any modifications to this product without prior express approval by Banner Engineering Corp will void the product warranties. All specifications published in this document are subject to change; Banner reserves the right to modify product specifications or update documentation at any time. Specifications and product information in English supersede that which is provided in any other language. For the most recent version of any documentation, refer to: www.bannerengineering.com.

For patent information, see www.bannerengineering.com/patents.