

WLS27 LED Strip Light



Instruction Manual

Banner's WLS27 LED Strip Lights have sturdy aluminum housings, encased in shatterproof, UV-stabilized, copolyester shells, making them ideal for harsh indoor and outdoor applications.

- Low-profile, space-saving design
- Rugged, water-resistant IP69K option
- Available in eight lengths from 145 to 1130 mm
- Daisy chain power to multiple lights
- Optional snap clips for easy installation and repositioning
- Capability to dim lights using the wiring pinout (Hi/Lo/Off)
- Automatic temperature protection built into the unit. Above 50 °C, the light dims to manage heat and protect product lifetime



Stand-Alone Light or End Light in a Cascade—QD

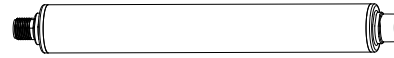

First or Middle of a Cascade—QD

These Work Light Strips are available as either stand-alone models, or as cascade models that can be "daisy-chained" together for a continuous length of lighting, with a minimum of wiring.

Stand-alone models have a male quick disconnect (QD) at one end for power connection and no connections at opposite end. A stand-alone model may be used as the last in the cascade series.

Cascade models have a male quick disconnect (QD) at one end for power connection, and a female QD at the opposite end for connecting to other lights in the cascade. A double-ended accessory cordset must be used between each pair of lights in a cascade.

Use single-ended cordsets between the power source and the QD connection of a stand-alone light or the first light in a cascade. Use double-ended cordsets between lights in a cascade.

Models

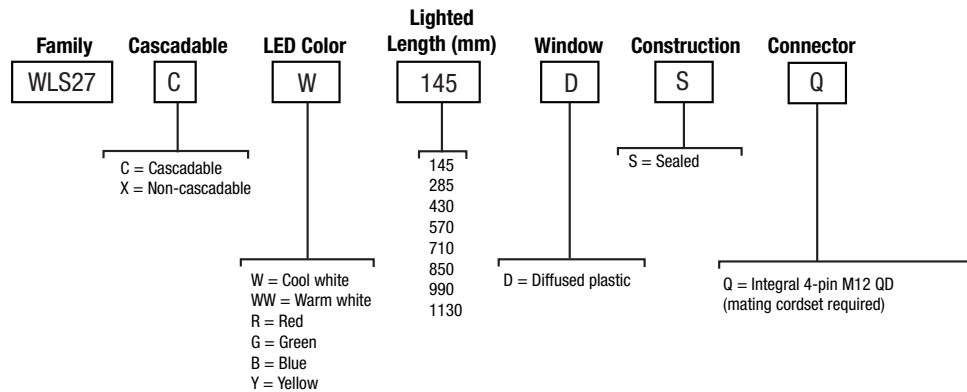

Models		Lighted Length	Power Connector
Stand-Alone	Cascade		
WLS27XW145DSQ	WLS27CW145DSQ	145 mm	Integral 4-pin M12/Euro-style quick disconnect
WLS27XW285DSQ	WLS27CW285DSQ	285 mm	
WLS27XW430DSQ	WLS27CW430DSQ	430 mm	
WLS27XW570DSQ	WLS27CW570DSQ	570 mm	
WLS27XW710DSQ	WLS27CW710DSQ	710 mm	
WLS27XW850DSQ	WLS27CW850DSQ	850 mm	



Models		Lighted Length	Power Connector
Stand-Alone	Cascade		
WLS27XW990DSQ	WLS27CW990DSQ	990 mm	
WLS27XW1130DSQ	WLS27CW1130DSQ	1130 mm	

Specifications

Supply Voltage

12 to 30 V dc

Use only with suitable Class 2 power supply (UL) or a SELV power supply (CE).

Light Length	Typical Current			Max. Current	Lumens (Typical at 25 °C)					
	12 V dc	24 V dc	30 V dc	A	Cool White	Warm White	Green	Red	Yellow	Blue
145 mm	0.33 A	0.15 A	0.12 A	0.4	325	325	180	55	50	40
285 mm	0.66 A	0.30 A	0.24 A	0.8	650	650	360	110	100	80
430 mm	1.01 A	0.46 A	0.36 A	1.2	975	975	540	165	150	120
570 mm	1.36 A	0.61 A	0.48 A	1.6	1300	1300	720	220	200	160
710 mm	1.75 A	0.77 A	0.60 A	2.0	1625	1625	900	275	250	200
850 mm	2.13 A	0.92 A	0.73 A	2.4	1950	1950	1080	330	300	240
990 mm	2.59 A	1.08 A	0.85 A	2.8	2275	2275	1260	385	350	280
1130 mm	3.04 A	1.24 A	0.97 A	3.2	2600	2600	1440	440	400	320

Supply Protection Circuitry

Protected against reverse polarity and transient voltages

Light Characteristics

Cool white

Color Temperature (CCT): 6000–7100K

Lumen output: 650 (± 5%) per foot, typical at 25 °C (77 °F)

Luminous efficacy: 90 lumens/Watt typical at 24 V dc at 25 °C (77 °F)

CRI: 85, typical

Warm white: 2850–3250K

Green: 525 nm

Red: 618 nm

Yellow: 590 nm

Blue: 460 nm

Application Note

When connecting cascaded lights in series at 100% intensity, it is important not to exceed maximum current limitations:

Maximum length of light at 12 V dc: 1.4 m (4.6 ft)

Maximum length of light at 24 V dc: 3.0 m (9.8 ft)

Maximum length of light at 30 V dc: 3.1 m (10.2 ft)

At 50% intensity, double the lengths.

Certifications



LED Lifetime

Lumen Maintenance - L₇₀

When operating within specifications, output will decrease less than 30% after 50,000 hours.

Construction

Clear anodized aluminum housing; FDA-grade copolyester outer housing

Mounting

Bracket LMBWLS27EC included (2 for lights up to 570 mm or 3 for lights 710 mm and longer)

Connections

Integral 4-pin M12 male quick disconnect (QD) (4-pin connecting cordset required)

Environmental Rating

Rated IEC IP66, IP67, and IP69K, per DIN 40050

Operating Temperature

-40 °C to +70 °C (-40 °F to +158 °F)

Light output begins to decrease above 50 °C (122 °F) and will be approximately 65% of max intensity at 60 °C (140 °F) and 30% of max intensity at 70 °C (158 °F)

Storage Temperature

-40 °C to +70 °C (-40 °F to +158 °F)

Vibration and Mechanical Shock

Vibration 10-55 Hz 1.0 mm p-p amplitude per IEC 60068-2-6

Shock 15G 11 ms duration, half sine wave per IEC 60068-2-27



Note: Do not spray cable with high-pressure sprayer, or cable damage will result.

Performance

For models with heavy diffused housing, multiply lumen values by 0.8.

145 mm Models

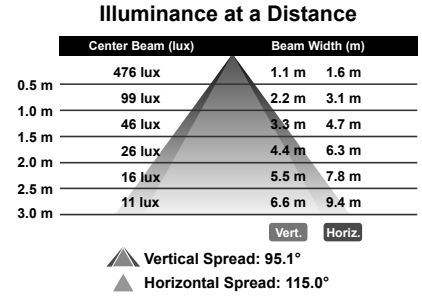
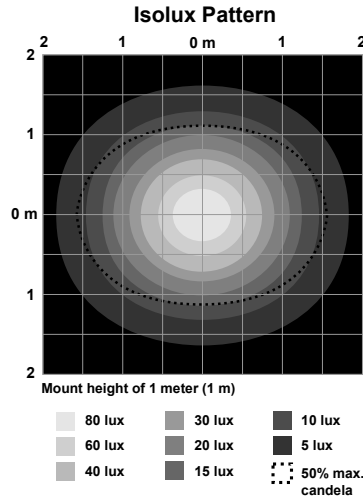
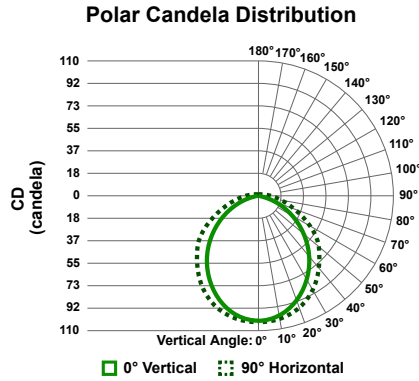

285 mm Models

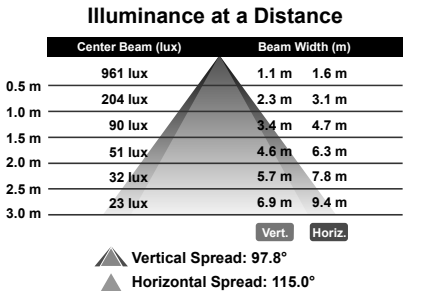
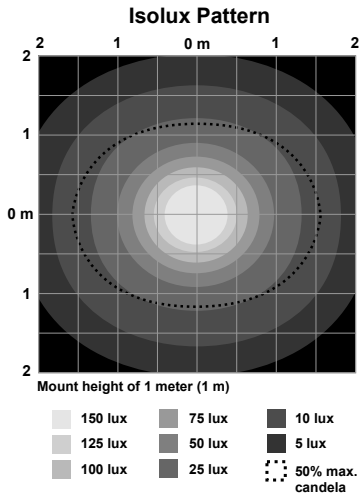
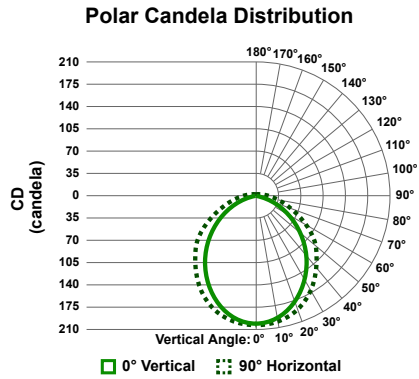

430 mm Models

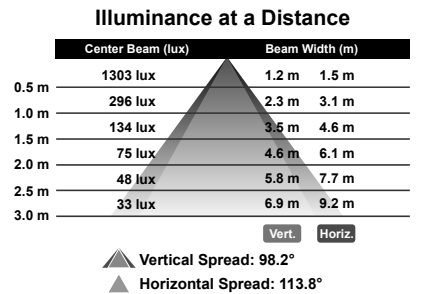
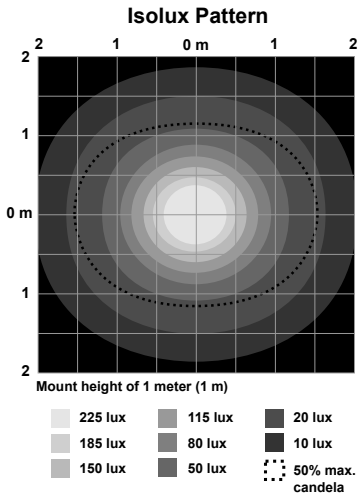
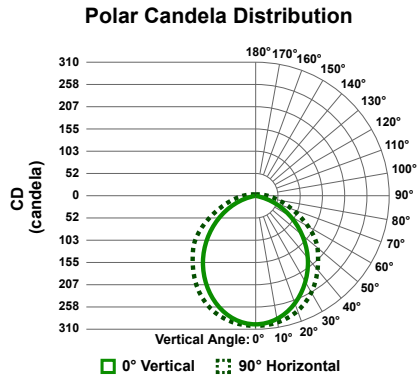

570 mm Models

Polar Candela Distribution

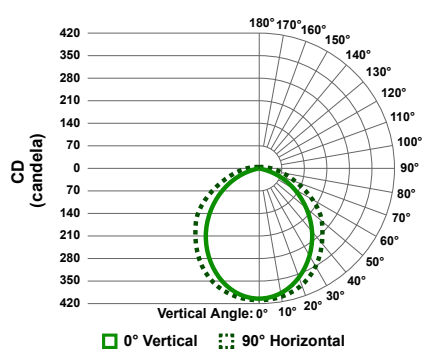

Isolux Pattern

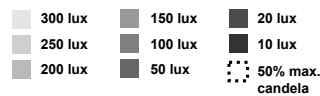
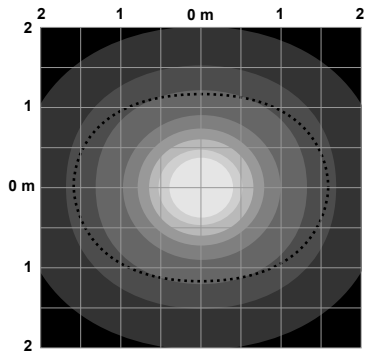

Illuminance at a Distance

	Center Beam (lux)	Beam Width (m)	
0.5 m	1539 lux	1.2 m	1.6 m
1.0 m	379 lux	2.3 m	3.2 m
1.5 m	177 lux	3.5 m	4.8 m
2.0 m	99 lux	4.6 m	6.4 m
2.5 m	64 lux	5.8 m	8.0 m
3.0 m	44 lux	7.0 m	9.5 m

Vertical Spread: 98.5°
Horizontal Spread: 115.7°

710 mm Models

Polar Candela Distribution

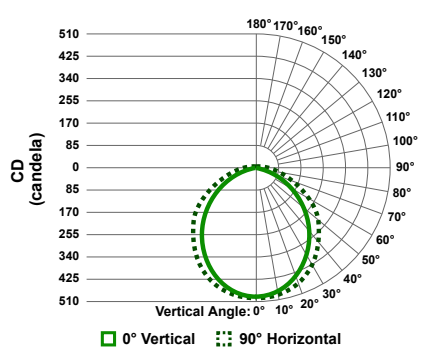

Isolux Pattern

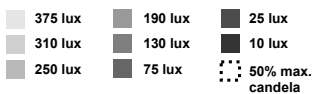
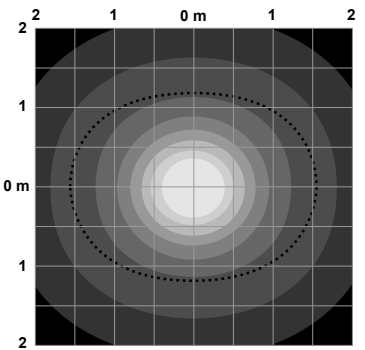

Illuminance at a Distance

	Center Beam (lux)	Beam Width (m)	
0.5 m	1778 lux	1.2 m	1.6 m
1.0 m	469 lux	2.3 m	3.1 m
1.5 m	221 lux	3.5 m	4.7 m
2.0 m	124 lux	4.7 m	6.2 m
2.5 m	80 lux	5.9 m	7.8 m
3.0 m	55 lux	7.0 m	9.3 m

Vertical Spread: 99.1°
Horizontal Spread: 114.5°

850 mm Models

Polar Candela Distribution

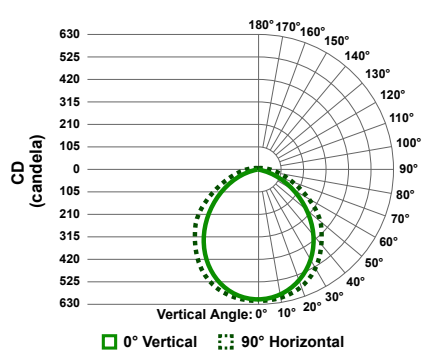

Isolux Pattern

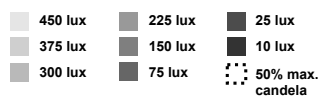
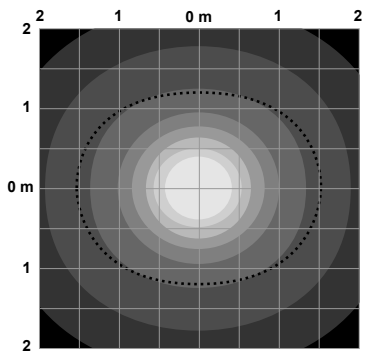

Illuminance at a Distance

	Center Beam (lux)	Beam Width (m)	
0.5 m	1925 lux	1.2 m	1.5 m
1.0 m	548 lux	2.4 m	3.1 m
1.5 m	279 lux	3.6 m	4.6 m
2.0 m	157 lux	4.8 m	6.1 m
2.5 m	100 lux	6.0 m	7.7 m
3.0 m	70 lux	7.2 m	9.2 m

Vertical Spread: 100.2°
Horizontal Spread: 113.7°

990 mm Models

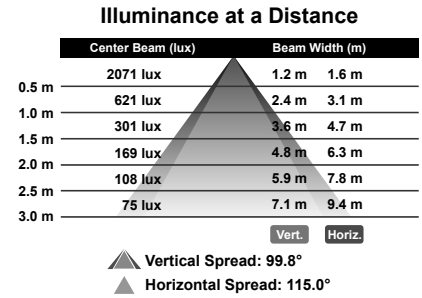
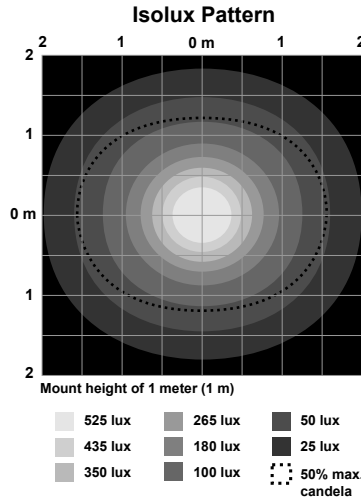
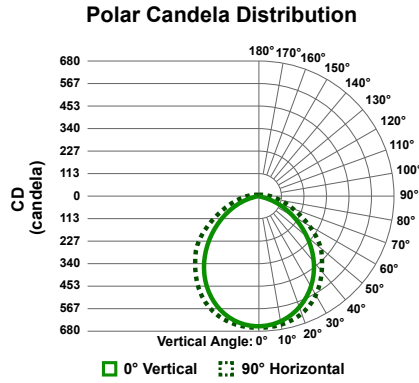

1130 mm Models

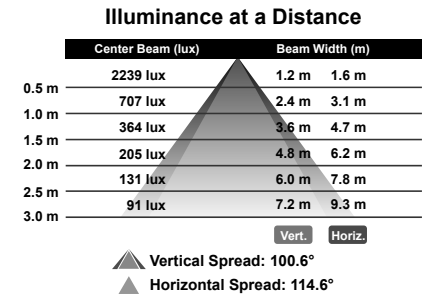
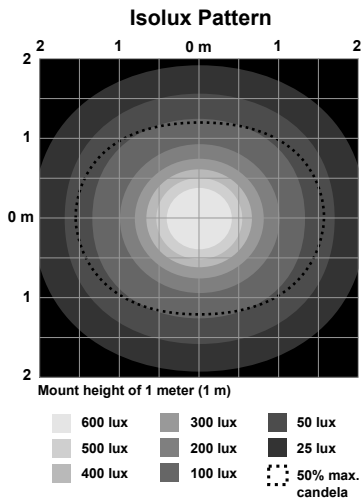
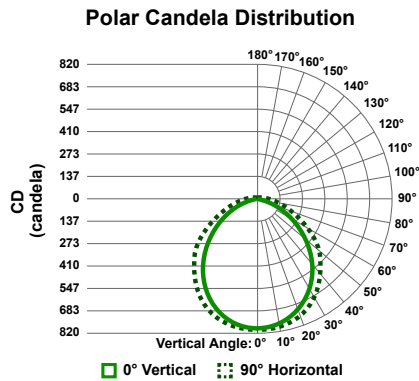

Dimensions

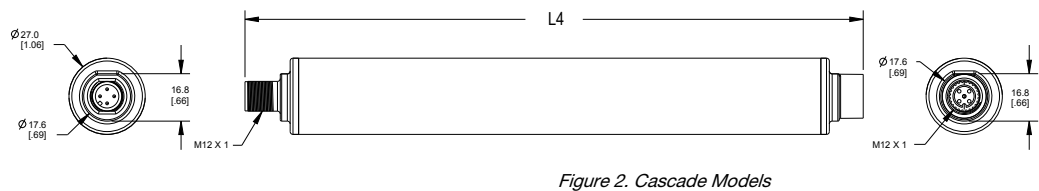
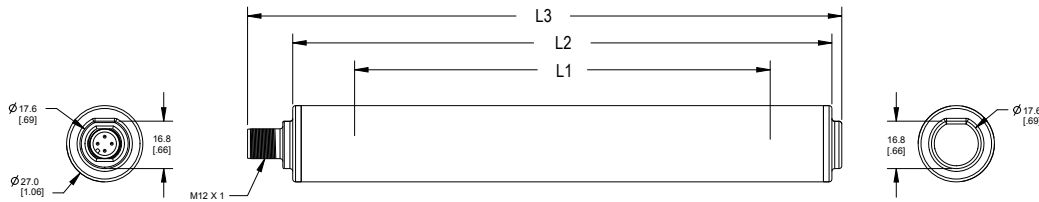

Models	L1	L2	L3	L4
WLS27..145..	145 mm (5.7 in)	189 mm (7.4 in)	208.5 mm (8.2 in)	217 mm (8.5 in)
WLS27..285..	286 mm (11.3 in)	330 (13 in)	349.5 mm (13.8 in)	358 mm (14.1 in)
WLS27..430..	427 mm (16.8 in)	471 mm (18.5 in)	490.5 mm (13.3 in)	499 mm (19.6 in)
WLS27..570..	569 mm (22.4 in)	612 mm (24.1 in)	631.5 mm (24.9 in)	640 mm (25.2 in)
WLS27..710..	708 mm (27.9 in)	752 mm (29.6 in)	771.5 mm (30.4 in)	780 mm (30.7 in)
WLS27..850..	849 mm (33.4 in)	893 mm (35.2 in)	912.5 mm (35.9 in)	921 mm (36.2 in)
WLS27..990..	991 mm (39 in)	1035 mm (40.8 in)	1054.5 mm (41.5 in)	1063 mm (41.8 in)
WLS27..1130..	1120 mm (44.1 in)	1164 mm (45.8 in)	1183.5 mm (46.4 in)	1192 mm (46.9 in)

Wiring Diagram

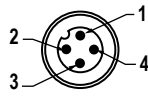
4-pin M12/Euro-style male QD	Pin	Wire Color	Connection
	1	brown	12 to 30 V dc
	3	blue	dc common
	4	black	Connect to 12 to 30 V dc for 50% maximum intensity. For maximum intensity, leave the black wire floating or connected to common .
	2	white	Not used

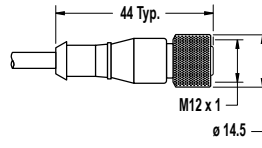
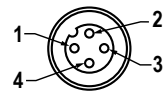

Accessories

Cordsets

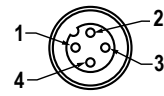
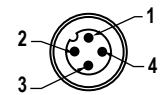
4-Pin Threaded M12/Euro-Style Cordsets—Single Ended				
Model	Length	Style	Dimensions	Pinout (Female)
MQDC-406	1.83 m (6 ft)	Straight		 <p>1 = Brown 2 = White 3 = Blue 4 = Black</p>
MQDC-415	4.57 m (15 ft)			
MQDC-430	9.14 m (30 ft)			
MQDC-450	15.2 m (50 ft)	Right-Angle		
MQDC-406RA	1.83 m (6 ft)			
MQDC-415RA	4.57 m (15 ft)			
MQDC-430RA	9.14 m (30 ft)			
MQDC-450RA	15.2 m (50 ft)			

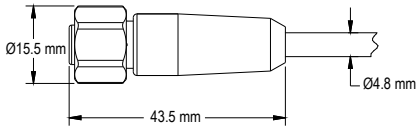
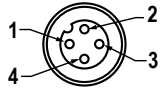
4-Pin Threaded M12/Euro-Style Cordsets—Double Ended				
Model	Length	Style	Dimensions	Pinout
MQDEC-401SS	0.31 m (1 ft)	Male Straight/ Female Straight		Female
MQDEC-403SS	0.91 m (3 ft)			
MQDEC-406SS	1.83 m (6 ft)			Male
MQDEC-412SS	3.66 m (12 ft)			
MQDEC-420SS	6.10 m (20 ft)			
MQDEC-430SS	9.14 m (30 ft)			
MQDEC-450SS	15.2 m (50 ft)			<p>1 = Brown 2 = White 3 = Blue 4 = Black</p>

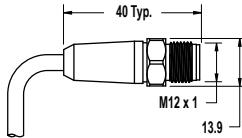
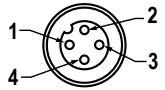
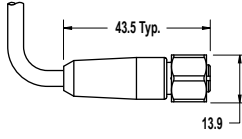
4-Pin Threaded M12/Euro-Style Cordsets—Washdown, Stainless Steel, Single Ended				
Model	Length	Style	Dimensions	Pinout (Female)
MQDC-WDSS-0406	1.83 m (6 ft)	Straight		 <p>1 = Brown 2 = White 3 = Blue 4 = Black</p>
MQDC-WDSS-0415	4.57 m (15 ft)			
MQDC-WDSS-0430	9.14 m (30 ft)			

4-Pin Threaded M12/Euro-Style Cordsets—Double Ended, Washdown, Stainless Steel				
Model	Length	Style	Dimensions	Pinout
MQDEC-WDSS-401SS	0.3 m (1 ft)	Male Straight/ Female Straight		Female
MQDEC-WDSS-403SS	0.91 m (3 ft)			
MQDEC-WDSS-406SS	1.83 m (6 ft)			Male
MQDEC-WDSS-412SS	3.66 m (12 ft)			 <p>1 = Brown 2 = White 3 = Blue 4 = Black</p>

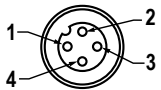
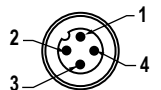
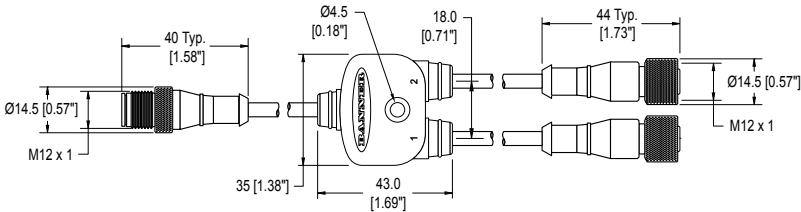
4-Pin Threaded M12/Euro-Style Splitter Cordsets—Flat Junction			
Model	Branches (Female)	Trunk (Male)	Pinout
CSB-M1240M1240	No branch	No trunk	 <p>Female</p>  <p>Male</p> <p>1 = Brown 2 = White 3 = Blue 4 = Black</p>
CSB-M1240M1241	2 x 0.30 m (1 ft)	No trunk	
CSB-M1241M1241		0.30 m (1 ft)	
CSB-M1248M1241		2.50 m (8 ft)	
CSB-M12415M1241		4.57 m (15 ft)	
CSB-M12425M1241		7.60 m (25 ft)	
CSB-UNT425M1241		7.60 m (25 ft) unterminated	
			

Brackets

LMBWLS27EC

- Clear copolyester
- Clearance for M5 or #10 hardware

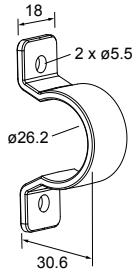

LMBWLS27H

- 300 series stainless steel mounting brackets
- M4 stainless steel hardware included

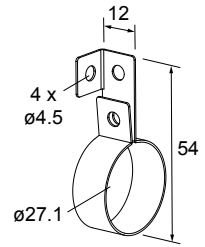

LMBWLS27SP

- Clear copolyester
- Clearance for M5 or #10 hardware
- Snap bracket for light duty applications

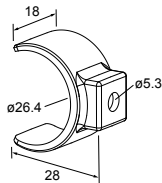

LMBWLS27T

- Stainless steel mounting brackets with rubber grips
- M5 stainless steel hardware included
- Clearance for M5 or #10 hardware

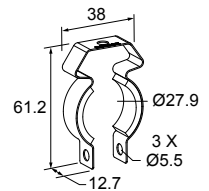

LMBWLS27U

- Clear copolyester
- Clearance for M5 or #10 hardware
- Clamps securely around the light body

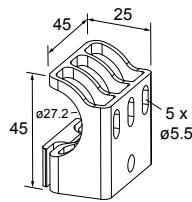

Banner Engineering Corp. Limited Warranty

Banner Engineering Corp. warrants its products to be free from defects in material and workmanship for one year following the date of shipment. Banner Engineering Corp. will repair or replace, free of charge, any product of its manufacture which, at the time it is returned to the factory, is found to have been defective during the warranty period. This warranty does not cover damage or liability for misuse, abuse, or the improper application or installation of the Banner product.

THIS LIMITED WARRANTY IS EXCLUSIVE AND IN LIEU OF ALL OTHER WARRANTIES WHETHER EXPRESS OR IMPLIED (INCLUDING, WITHOUT LIMITATION, ANY WARRANTY OF MERCHANTABILITY OR FITNESS FOR A PARTICULAR PURPOSE), AND WHETHER ARISING UNDER COURSE OF PERFORMANCE, COURSE OF DEALING OR TRADE USAGE.

This Warranty is exclusive and limited to repair or, at the discretion of Banner Engineering Corp., replacement. **IN NO EVENT SHALL BANNER ENGINEERING CORP. BE LIABLE TO BUYER OR ANY OTHER PERSON OR ENTITY FOR ANY EXTRA COSTS, EXPENSES, LOSSES, LOSS OF PROFITS, OR ANY INCIDENTAL, CONSEQUENTIAL OR SPECIAL DAMAGES RESULTING FROM ANY PRODUCT DEFECT OR FROM THE USE OR INABILITY TO USE THE PRODUCT, WHETHER ARISING IN CONTRACT OR WARRANTY, STATUTE, TORT, STRICT LIABILITY, NEGLIGENCE, OR OTHERWISE.**

Banner Engineering Corp. reserves the right to change, modify or improve the design of the product without assuming any obligations or liabilities relating to any product previously manufactured by Banner Engineering Corp. Any misuse, abuse, or improper application or installation of this product or use of the product for personal protection applications when the product is identified as not intended for such purposes will void the product warranty. Any modifications to this product without prior express approval by Banner Engineering Corp will void the product warranties. All specifications published in this document are subject to change; Banner reserves the right to modify product specifications or update documentation at any time. Specifications and product information in English supersede that which is provided in any other language. For the most recent version of any documentation, refer to: www.bannerengineering.com.

For patent information, see www.bannerengineering.com/patents.